



IA

ACTIVE BLADE
INTERNAL HEXAGON

company profile



RESISTA[®]

Marchio di proprietà della **Ing. Carlo Alberto ISSOGLIO & C. S.r.l.** identifica l'intera gamma di prodotti concepiti dall'azienda per soddisfare le esigenze di odontoiatri ed odontotecnici.

since 1946

RESISTA è sinonimo di garanzia, equilibrio e continuità, noto in tutto il mondo.



RESISTA, trademark owned by Ing. Carlo Alberto Issoglio & C. S.r.l. , identifies the full range of products designed by the company to meet the needs of dentists and dental technicians.

RESISTA is known all over the world since 1946, and synonymous of guarantee, balance and continuity.

company profile

L'azienda dispone di un complesso produttivo per la realizzazione di dispositivi medici, tra i più moderni del settore, situato ad Omegna, una bellissima cittadina che si affaccia sul Lago d'Orta.

Con impegno, vanto ed orgoglio, il personale tecnico e scientifico del reparto Ricerca & Sviluppo è quotidianamente dedicato a promuovere l'innovazione ed il miglioramento dei nostri prodotti e processi.



Negli anni, il marchio **RESISTA** è diventato anche sinonimo di risposta rapida e qualitativa ai cambiamenti del mercato e alle esigenze dell'odontoiatria moderna.

Qualità, Prezzo e Servizio riassumono in tre semplici parole la percezione quotidiana degli utilizzatori dei prodotti marchiati **RESISTA**.



The company has one of the most ip-to-date manufacturing site for the medical devices, located in Omegna, a beautiful town on Orta Lake, Italy.

With commitment, merit and pride, the technical and scientific staff of the R&D department is daily involved to promote innovation and the improvement of our products and processes.

Over the years, the **RESISTA** brand has also become synonymous of fast and qualitative response to market changes and the needs of modern dentistry.

Quality, Price and Service summarize in three simple words the daily perception of the users of **RESISTA** branded products.

the choice

RICERCA & SVILUPPO - Il programma R&D di Resista Group nasce dalle indicazioni provenienti dal mondo clinico unite alla nostra esperienza maturata nel campo dei dispositivi medici impiantabili.

Con l'utilizzo di programmi di modellazione 3D e sofisticati sistemi computerizzati simuliamo le geometrie finali ed il design, sviluppando le fasi di prototipizzazione rapida dei progetti.



INNOVAZIONI - Resista Group è strutturata per soddisfare tutte le esigenze del metal-implant con una avanzata tecnologia di concezione, prototipizzazione ed ingegnerizzazione finale del prodotto per arrivare a soluzioni innovative.

La validazione viene eseguita in collaborazione con Istituti di Ricerca accreditati in conformità ai requisiti degli Standard Internazionali.



RESEARCH & DEVELOPMENT - The R&D Resista Group's program stems from indications from the clinical world combined with our experience in the field of implantable medical devices.

Due to the use of 3D modeling programs and sophisticated computer systems, we simulate the final geometries and the design, developing the rapid prototyping phases of the projects.

INNOVATIONS - Resista Group is structured to meet all the needs of the metal-implant with an advanced conception technology, prototyping and final product engineering to arrive at innovative solutions. Validation is carried out in collaboration with accredited Research Institutes following the International Standards Requirements.

the choice

QUALITÀ DI PROGETTO E PROCESSO - ICIM Spa ha certificato la **Ing. C. A. Issoglio & C. S.r.l.** in accordo alle normative **UNI EN ISO 9001** e **UNI EN ISO 13485** nel rispetto di tutte le normative vigenti relative ai prodotti e servizi offerti.

Ogni dipendente che ricopre differenti ruoli (tecnici, ingegneristici, amministrativi, commerciali, operatori meccanici, ecc), segue linee guida ed obiettivi per un unico fine: il miglioramento continuo.



OBIETTIVO PRINCIPALE - La soddisfazione del cliente è il nostro obiettivo. Il fattore vincente è la capacità dell'azienda a risolvere nel breve qualsiasi tipo di richiesta.

Il supporto tecnico fornito dagli specialisti di prodotto, la disponibilità, l'efficienza e la cordialità sono il punto di forza della nostra struttura.



PROJECT AND PROCESS QUALITY - ICIM Spa certified **Ing. C. A. Issoglio & C. S.r.l.** in accordance with **UNI EN ISO 9001** and **UNI EN ISO 13485** in compliance with all current regulations relating to the products and services offered. Every employee covering different roles (technical, engineering, administrative, commercial, mechanic operators, etc.), follows guidelines and objectives for a single purpose: continuous product improvement.

MAIN OBJECTIVE - Customer satisfaction is our objective. The winning factor is the company's ability to quickly resolve any type of request. The technical support provided by Product Specialists, availability, efficiency and friendliness are the strengths of our structure.

the project

CONCETTI BIOMECCANICI - Il successo della metodica implantare **Resista Group** è frutto di approfonditi studi sul design dei prodotti e sulla tecnologia di produzione. I risultati clinici a lungo termine sono, infatti, fortemente influenzati dalla precisione e dalla qualità.

Il **processo produttivo** viene eseguito da operatori altamente qualificati che, con l'ausilio dei sistemi elettronici CNC automatizzati, riescono ad ottenere risultati ottimali e riproducibili.



Le tolleranze di lavorazione, soprattutto negli **accoppiamenti protesici**, sono il nostro **gold standard** e vengono confinate tra i **7 - 10 μm** .

MATERIALI - Gli impianti sono realizzati in **Titanio ASTM Gr 4** (Norm. ISO 5832/2), le viti di ritenzione e le componenti protesiche sono realizzate in **Leghe di Titanio ASTM Gr 5** (Norm. ISO 5832/3).



BIOMECHANICAL CONCEPTS - The **Resista Group** method success is the result of several product design studies and the high technology applied in the production. The precision and reliability of the implant has a strong influence on the long term clinical success.

The manufacturing process is carried out by high qualified operators, skilled enough to obtain optimal and reproducible results with the use of electronically controlled CNC machinery. The machinery tolerances, especially in **prosthetic connections**, are our **gold standard** and are between **7 - 10 μm** .

MATERIALS - The implants are made of Titanium ASTM Gr. 4 (ISO Standard 5832/2) and the screws and prosthetic components are made of Titanium ASTM Gr. 5 (ISO Standard 5832/3).

the project

TRATTAMENTI DI SUPERFICIE - Il processo di micro-sottrazione non contaminata, doppia acidificazione **DAE** (Double Acid Etching), modifica la micro rugosità degli impianti (**Ra, Rq**) texturizzando la superficie e massimizzando la bagnabilità ed il biomimetismo.

Il trattamento di superficie ed il processo di decontaminazione, brevettati da **Nobil Bio Ricerche**, sono in grado di migliorare le proprietà bio-chimiche degli impianti dentali **Resista**.

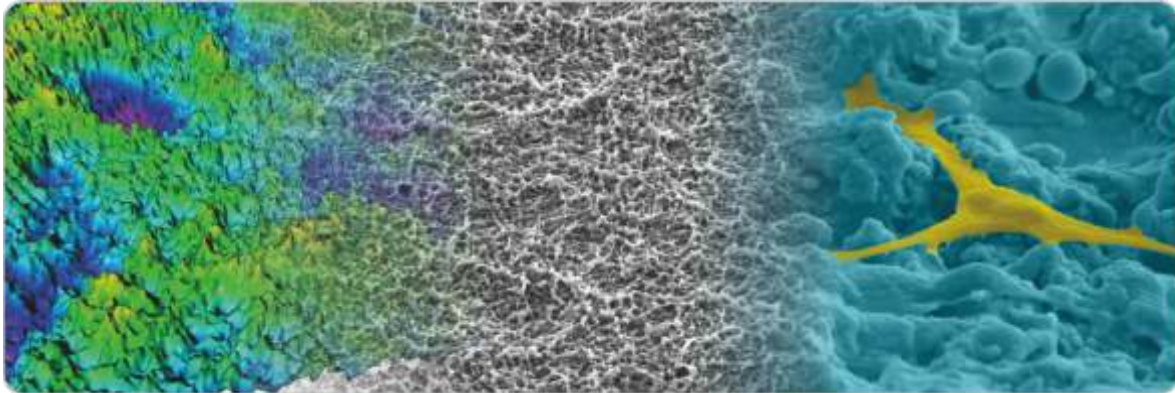

SISTEMA QUALITÀ - L'azienda è certificata in accordo alle norme **UNI EN ISO 9001** e **UNI EN ISO 13485** e ha ottenuto la marcatura **CE** sui propri dispositivi medici in accordo alla Direttiva Europea 93/42/CEE e ss.mm.ii. nel rispetto delle armonizzate di riferimento.

L'impegno è costante nel mantenimento della conformità.



SURFACE TREATMENTS - The non-contaminant micro-subtraction process, **DAE** (Double Acid Etching), changes the implant micro roughness (**Ra, Rq**) and the surface texture maximizing the wettability and biomimetic properties. The new surface treatment and decontamination process are patented by **Nobil Bio Ricerche** improving the bio-chemical properties of the implants.

QUALITY SYSTEM (QS) - **UNI EN ISO 9001** and **UNI EN ISO 13485** in compliance of Medical Devices Directives. We are qualified in the design and in the production management of dental implants, dental prosthesis, intraligamental anesthesia syringes and abrasive discs.

mounter - transfer - abutment - GCS

MOUNTER PREASSEMBLATO IN TITANIO GR 5 - Uno dei punti di forza della nostra linea **Resista** è il Dispositivo di Montaggio Multifunzione che viene utilizzato nelle **4** differenti applicazioni:

1 Prelievo ed avvitamento dell'impianto - **2** Transfer per impronta Closed Tray - **3** Abutment definitivo fino a 13° di correzione angolare - **4** Mounter per Chirurgia Computer Guidata

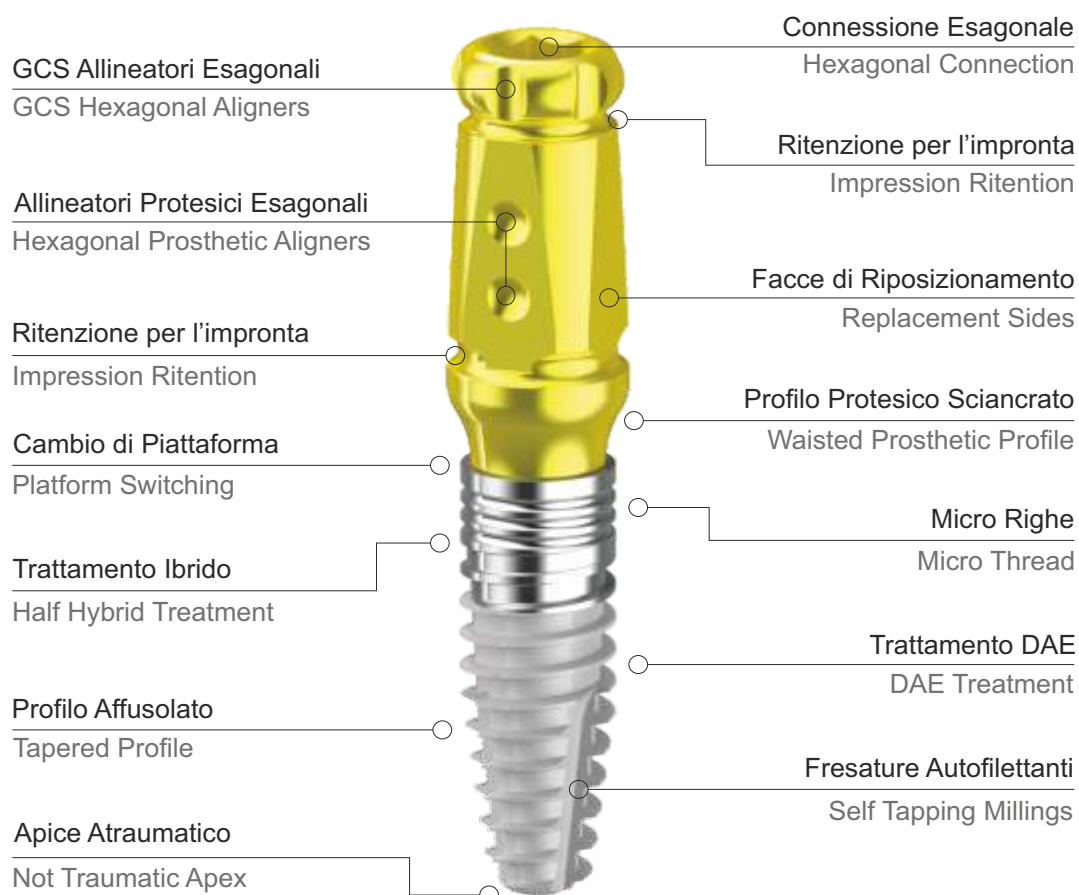

TITANIUM GR 5 PRE-ASSEMBLED MOUNTER - One of the strong points of our **Resista** line is the Multifunction Mounter Device that is used in the **4** following different applications:

1 Implant pick up and screwing - **2** Closed Tray Impression Transfer - **3** Definitive Abutment up to 13° angular correction - **4** Mounter for Computer Guided Surgery

mounter - transfer - abutment - GCS

MOUNTER TRANSFER - Transfer per la tecnica di impronta a **Strappo con Cucchiaino Chiuso**.

È una tecnica semplice, veloce ed efficace, adatta a tutte le tipologie di progetto protesico. Il Mounter Transfer è riposizionabile nell'impronta in un'unica posizione, definita dalle differenti facce e ritenzioni distribuite sulla superficie.

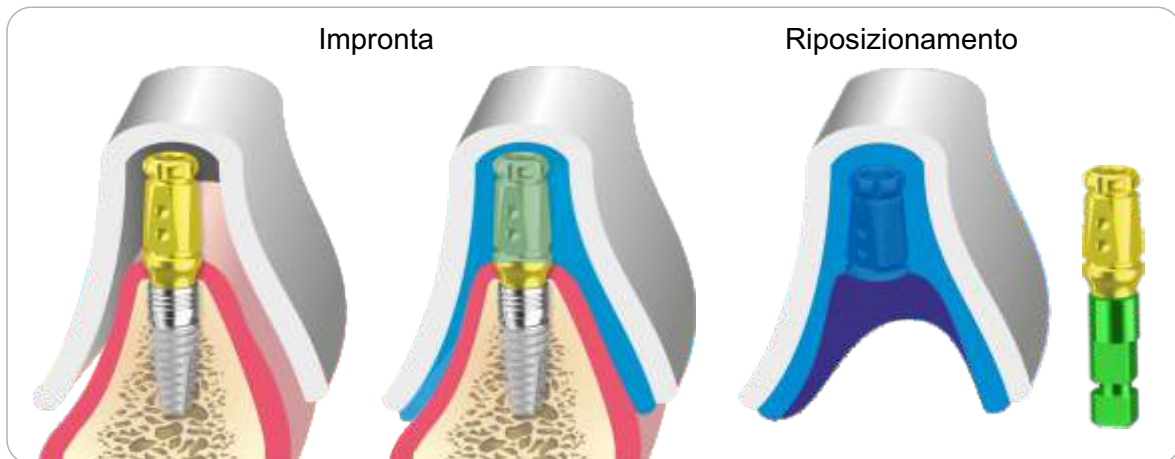

MOUNTER ABUTMENT - Moncone Protesico Definitivo completo di vite passante definitiva.

Il Mounter Moncone in Titanio Gr 5 è fresabile in altezza ed angolazione fino ad un massimo di 13°, utilizzando frese da laboratorio per Titanio.

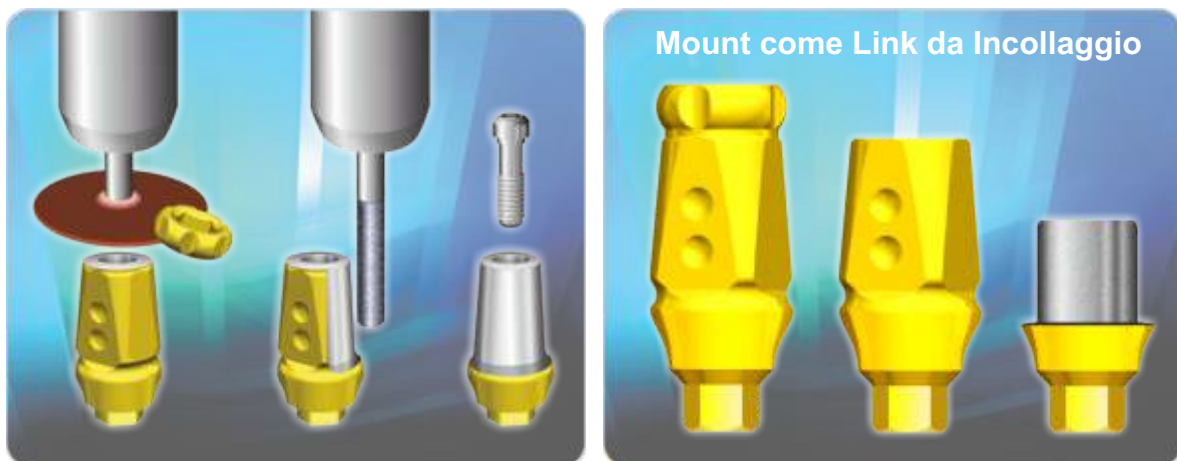

TRANSFER MOUNTER - Transfer for **Closed Tray Technique** (Elastic tear impression technique).

It is a simple, fast and effective technique, suitable for all types of prosthetic projects. The Transfer Mounter can be repositioned in the impression only in one position, defined by the different sides and retentions arranged on the surface.

ABUTMENT MOUNTER - Definitive Prosthetic Abutment complete with definitive through screw.

The Titanium Gr 5 Abutment Mounter can be milled in height and angle up to 13°, using laboratory drills for Titanium.

mounter - transfer - abutment - GCS

MOUNTER GCS - Mounter adatto per l'inserimento degli impianti in **Chirurgia Computer Guidata**.

Il diametro cilindrico del Mounter scorre in asse dentro le Boccole per Chirurgia Computer Guidata, mentre i 6 riferimenti di allineamento esagonale (tacche) stabiliscono la posizione finale.



FUNZIONE DEL MOUNTER ALL'INTERNO DELLA CONFEZIONE - Mantiene sollevato l'impianto dentro la confezione.

Il Mounter e l'impianto sono contenuti nella **Boccola in Titanio** che garantisce la qualità della superficie durante la rimozione in fase chirurgica, evitandone la contaminazione da strisciamento.

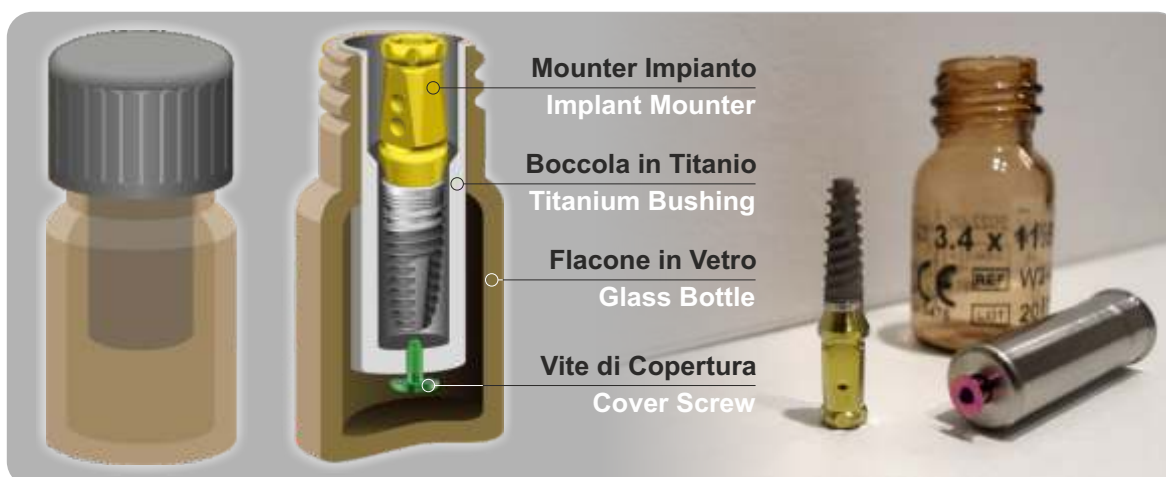

GCS MOUNTER - Mount suitable for implants placement by **Computer Guided Surgery**.

The cylindrical diameter of the Moulder glides on the axis inside the Bushings for Computer Guided Surgery, whereas the 6 hexagonal alignment reference points (notches) define the final position.

MOUNTER FUNCTION INSIDE THE PACKAGING - Hangs the implant inside the packaging.

The **Titanium Bushing** contains the Moulder and the implant and guarantees the quality of the surface during the removal surgical step, avoiding the contamination due to the scratching.

tooth - implant ratio

Resistenza Meccanica Implantare ed Indicazioni d'uso Implants Mechanical Resistance and Indications for Use

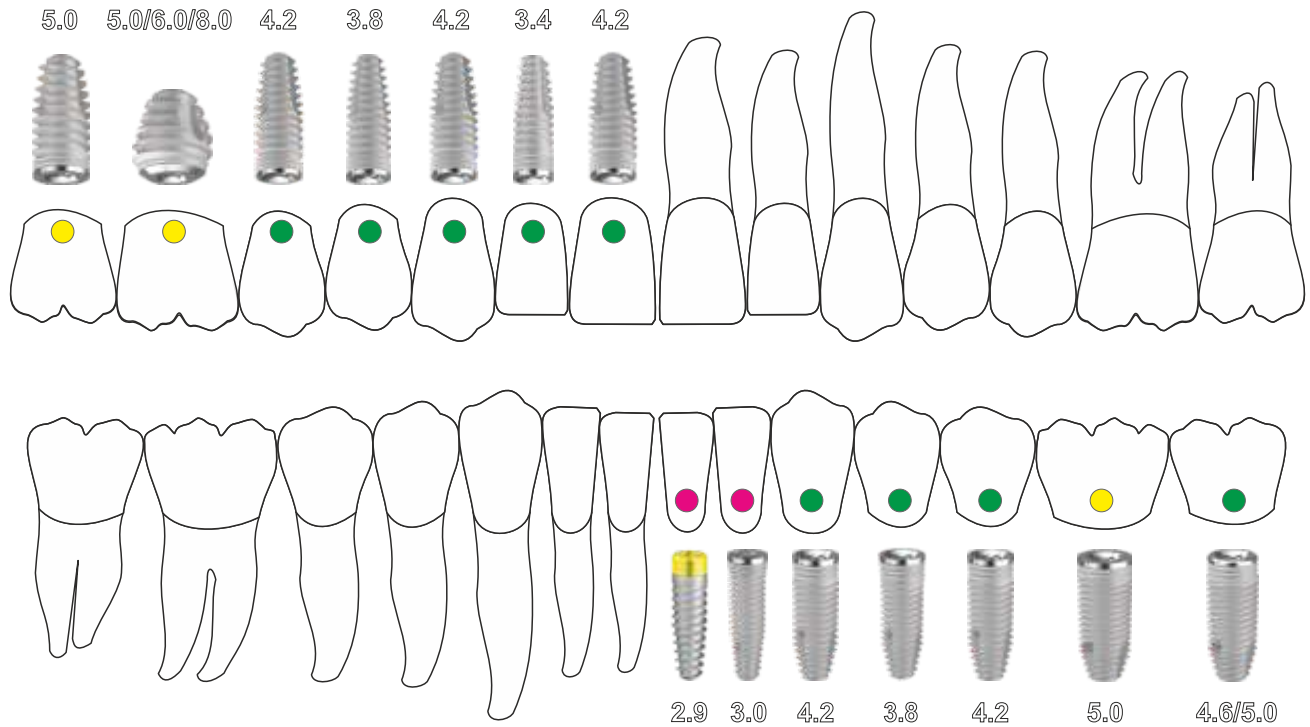

Esempi di Protesi Mista Denti/Impianti Bilanciata Examples of Balanced Teeth/Implants Prosthetics Mixed

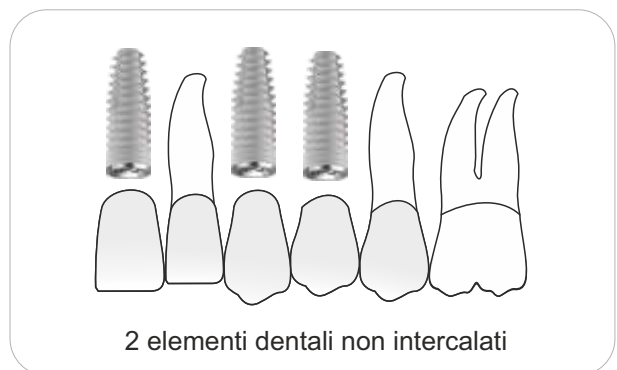
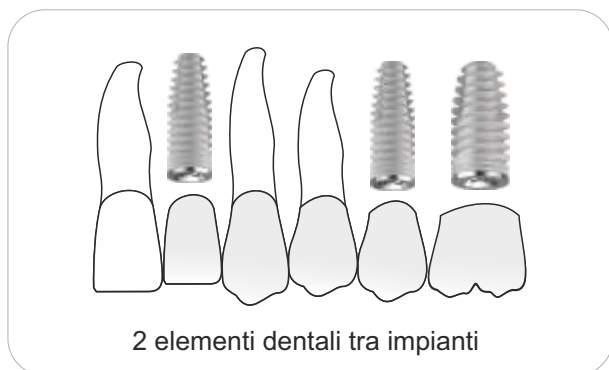
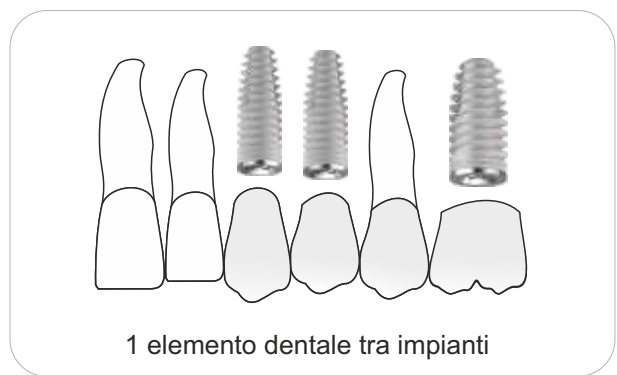
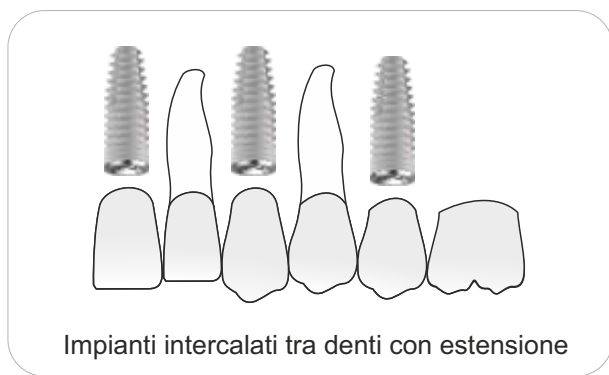

instruments & torque

Limiti sullo Scambio delle Forze tra Impianti e Strumenti Implants and Instruments Limits on Forces Exchanges

INTERNAL HEXAGON

Max 50 Ncm²

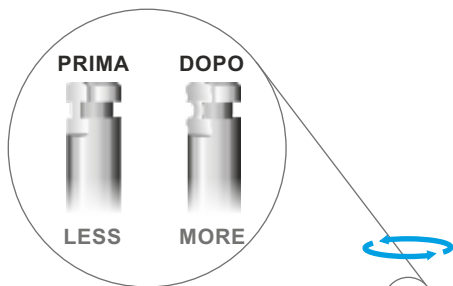

Max 150 Ncm²

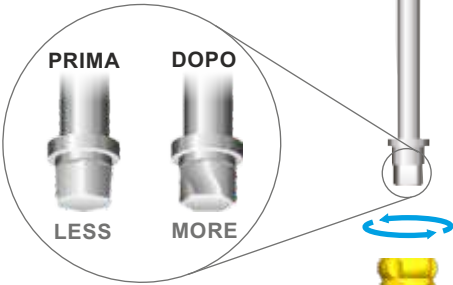

Max 120 Ncm²

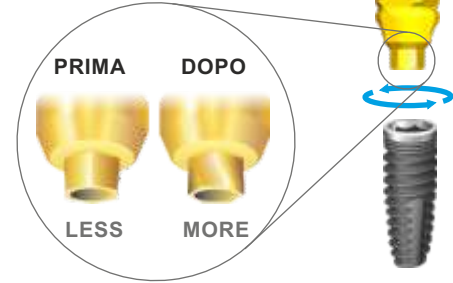

EXTERNAL HEXAGON

Max 50 Ncm²

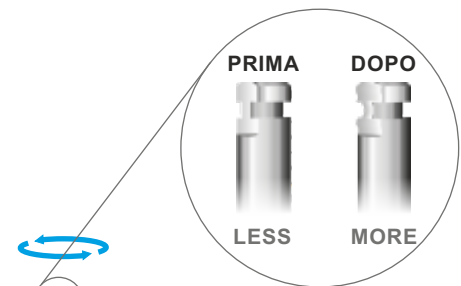

Max 150 Ncm²

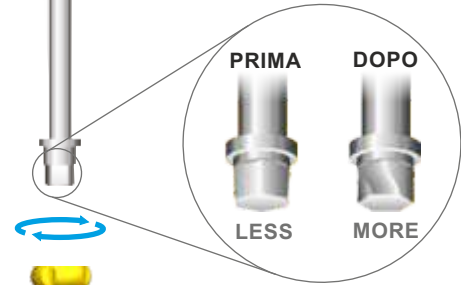

Max 70 Ncm²

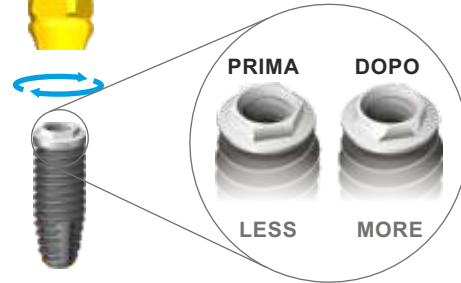

SCREW DRIVER HEXAGON

Max 40 Ncm²

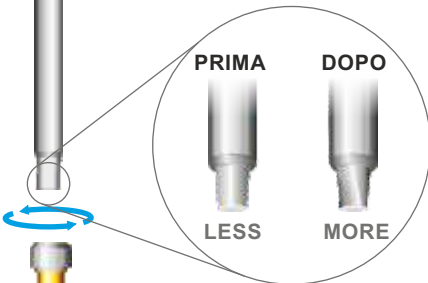

EPMV - Mini Vite Toronto **15 Ncm²**



IPVIT - Viti Protesiche **32 Ncm²**



IPVITG - Viti Protesiche **32 Ncm²**



EPVITG - Viti Protesiche **32 Ncm²**



EPVITB - Vite Protesica **32 Ncm²**



micro geometry

Il trattamento di superficie Micro-Nano Ruvido DAE accelera i processi di guarigione ossea

1. Rimuove i residui organici di lavorazione in combinazione con la Decontaminazione al Plasma d'Argon
2. Arrotonda gli angoli vivi eliminando i micro-difetti
3. Incrementa la superficie e la bagnabilità (idrofilia superficiale), migliorando l'adesione dei primi ponti di fibrina
4. Aumenta l'adesione proteica
5. Massimizza l'adesione cellulare con rugosità Micro-Nano Metriche ideali per l'ancoraggio dei filamenti di actina (filopodi)
6. Cambia la chimica superficiale del Titanio che migliorando in biocompatibilità incrementa la proliferazione e la vitalità cellulare

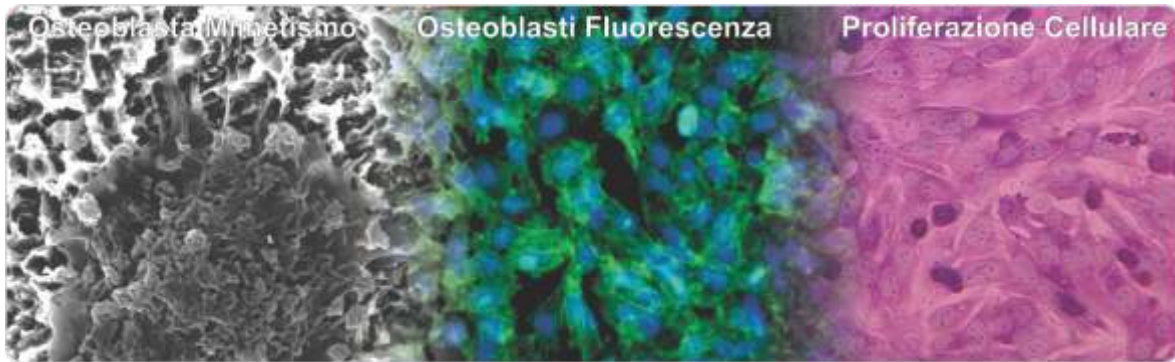

La topografia e la chimica di superficie interagiscono con i processi di differenziazione cellulare

La superficie implantare usa la microtopografia come linguaggio di comunicazione con le cellule del tessuto ospite. La pulizia in reattore al plasma freddo di Argon con confezionamento in ambiente controllato nell'assoluto rispetto delle procedure, gioca un ruolo fondamentale nel controllo delle endotossine adese (principale agente di risposta immunologica alle superfici implantari).

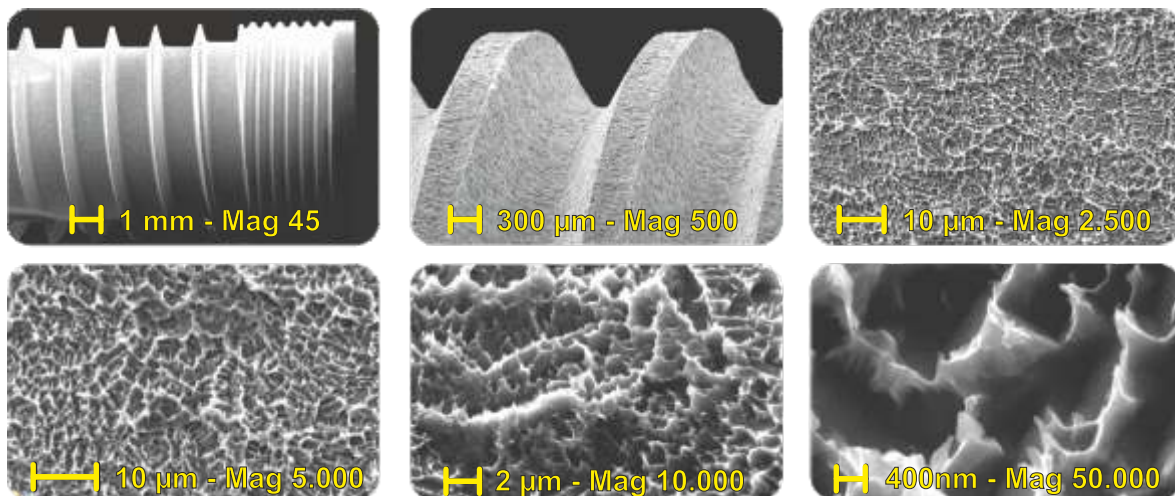

The Micro-Nano Rough DAE surface treatment speed up bone healing processes

1. Removes the manufacturing organic residuals along with Argon Plasma Cleaning
2. Smooths the edge and eliminates the micro-defects
3. Increases surface and wettability (hydrophilicity surface), improving the first fibrin bridges adhesion
4. Increases protein adhesion
5. Maximizes cellular adhesion through the Micro-Nano roughness suitable for actin filaments (phyllopods) anchoring
6. Changes the Titanium surface chemical characteristics improving the biocompatibility and increasing the cellular proliferation and vitality

Surface topography and chemistry interact with the cellular differentiation processes

The implant surface uses the microtopography as a communication language with the host tissue cells. The Plasma Argon Cold Cleaning with a controlled-environment packaging at a strict protocol procedures, play a key-role in the control of adhered endotoxins (main immunological response player to implant surfaces).

micro geometry - 4 treatments

DISTRIBUZIONE DEL TRATTAMENTO DI SUPERFICIE SULLA FORMA IMPLANTARE

Tutti gli impianti **Resista** presentano un trattamento di superficie localmente differenziato. La logica di distribuzione superficiale del trattamento è dettata dalla posizione endo-ossea dell'impianto che richiede caratteristiche differenti in funzione della presenza, più o meno ravvicinata della componente mucogengivale.

- 1. Superficie Machined:** Spazzolata, rettificata e mascherata nel processo di irruvidimento
- 2. Superficie Nanoruvida:** Trattamento veloce, nanoruvido con Ra medio inferiore al micron
- 3. Superficie Microruvida 3/5 μ :** Trattamento DAE, microruvido con Ra medio tra 3/5 micron
- 4. Superficie Microruvida 4/7 μ :** Trattamento DAE lento, microruvido con Ra medio tra 4/7 micron

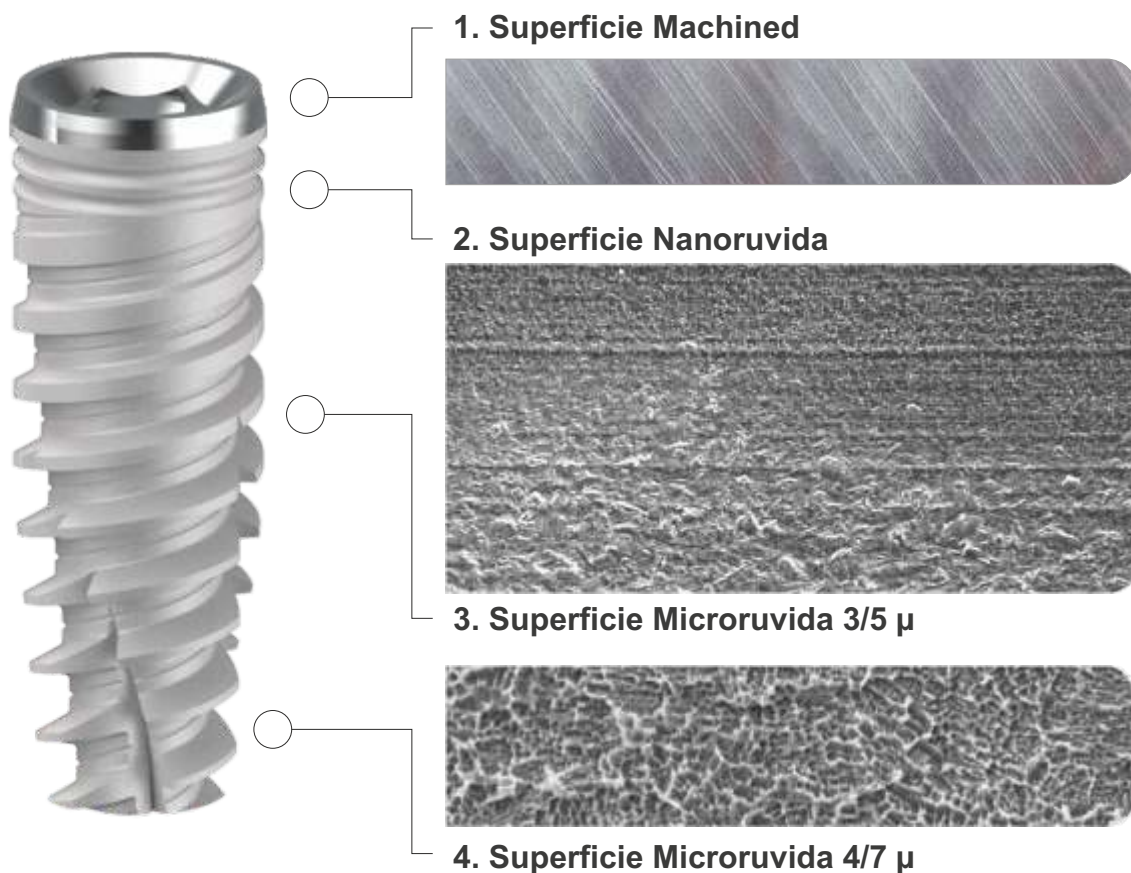

VEGF/VEGF-R/RUNX2 Upregulation in Human Periodontal Ligament Stem Cells Seeded on Dual Acid Etched Titanium Disk

Francesca Diomede, Guya Diletta Marconi, Marcos F. X. B. Cavalcanti, Jacopo Pizzicannella, Sante Donato Pierdomenico, Luigia Fonticoli, Adriano Piattelli and Oriana Trubiani

Materials 2020, 13, 706; doi:10.3390/ma13030706



SURFACE TREATMENT DISTRIBUTION ON IMPLANT'S BODY

All the **Resista's** implants have a surface treatment that is locally differentiated. The logic of surface treatment distribution is dictated by the endo-osseous implant position which requires different characteristics dependin on the muco-gingival component presence around.

- 1. Machined Surface:** Brushed, rectify and protected during the roughening process
- 2. Nano-rough Surface:** Speedy treatment, nano-rough with average Ra less than one micron
- 3. Micro-rough Surface: 3/5 μ :** DAE Treatment, micro-rough with average Ra between 3/5 μ
- 4. Micro-rough Surface: 4/7 μ :** DAE Slow Treatment, micro-rough with average Ra between 4/7 μ

PUNTI DI FORZA DELLA LINEA IMPLANTARE RESISTA

- 1. Macro Geometrie:** Vastissima gamma di forme implantari per le differenti necessità in campo chirurgico (Cilindrici, Tapered, Attivi, Short, Mini ed Extra-Larghi)
- 2. Micro Geometrie:** Trattamenti di superficie differenziati (Full, Half e Machined) di ultima generazione (DAE Micro e Nano rugosi), decontaminati in Reattore al Plasma Freddo di Argon.



The Bacterial Anti-Adhesive Activity of Double-Etched Titanium (DAE) as a Dental Implant Surface

Morena Petrini, Alessandra Giuliani, Emanuela Di Campi, Silvia Di Lodovico, Giovanna Iezzi, Adriano Piattelli and Simonetta D'Ercole¹
International Journal of Molecular Sciences 2020, 21, 8315; doi:10.3390/ijms21218315

- 3. Mounter Multifunzione:** 4 componenti in un unico articolo (Mounter, Transfer, Abutment e Mounter per Chirurgia Computer Guidata) per massimizzare la resa ed ottimizzare i costi.
- 4. Componenti protesiche:** Vastissima gamma di varianti protesiche con tolleranze di lavorazione sulle connessioni di 7 micron, con profili emergenti curvilinei, connessioni piane e coniche, platform switching, viti in Titanio Dorate e rivestimenti in PVD TiN (più estetica e minore ritenzione di placca).
- 5. Strumentario Chirurgico:** Frese chirurgiche **3-Tech**, massima efficienza, minima invasività, basso coefficiente di attrito, tecnologia **PRO MSD** per applicazione osseo-densificante in senso antiorario, lunga durata, perfetta visibilità delle tacche laser e stop chirurgici millimetrati.



THE RESISTA'S IMPLANT LINE STRONG POINTS

- 1. Macro Geometry:** A vast range of implant shapes for different surgical needs (Cylinder, Tapered, Active, Short, Mini and Extra-Large)
- 2. Micro Geometry:** Last Generation Differentiated Surface (Full, Half and Machined) treated (DAE Micro and Nano rough), decontaminated in Argon Cold Plasma Reactor.
- 3. Multifunctional Mounter:** 4 components in a single article (Mounter, Transfer, Abutment and Mounter for Computer Guided Surgery) to maximize result and minimize costs.
- 4. Prosthetic Parts:** A very wide range of prosthetic variants with 7/10 micron machining tolerances on the connection, with emerging curvilinear profiles, flat and conical connections, platform switching, golden titanium screws and PVD TiN coatings (more aesthetic and less retention of dental plaque).
- 5. Surgical Instruments:** Surgical Drills **3-Tech**, maximum efficiency, minimum trauma, smaller friction coefficient, **PRO MSD** technology for counterclockwise bone densifying application long, lasting resistance, perfect visibility of laser marking and surgical millimeters stop.

technology

COERENZA E LOGICA NEL RAPPORTO DIAMETRO FRESA/DIAMETRO NOCCILOLO-IMPIANTO

Le progettazioni della forma degli strumenti rotanti si basano sulla logica di coerenza tra la dimensione degli impianti, nell'ingombro esterno, nel nocciolo interno e per la loro capacità di penetrazione.

Gli **impianti cilindrici** della linea **IC** presentano una porzione apicale affusolata per una lunghezza di 3mm. Gli **impianti conici** della linea **IK** presentano una porzione apicale affusolata per una lunghezza di 5mm.

Le frese si presentano rispettivamente con 2 / 3 sezioni apicali, adeguate per una preparazione del tunnel implantare rispetto alla geometria dell'impianto, mantenendo il miglior BIC di interfaccia osso / impianto.

Ogni gradino è fornito di un tagliente affilato per agevolare la penetrazione, minimizzando l'attrito ed il surriscaldamento.

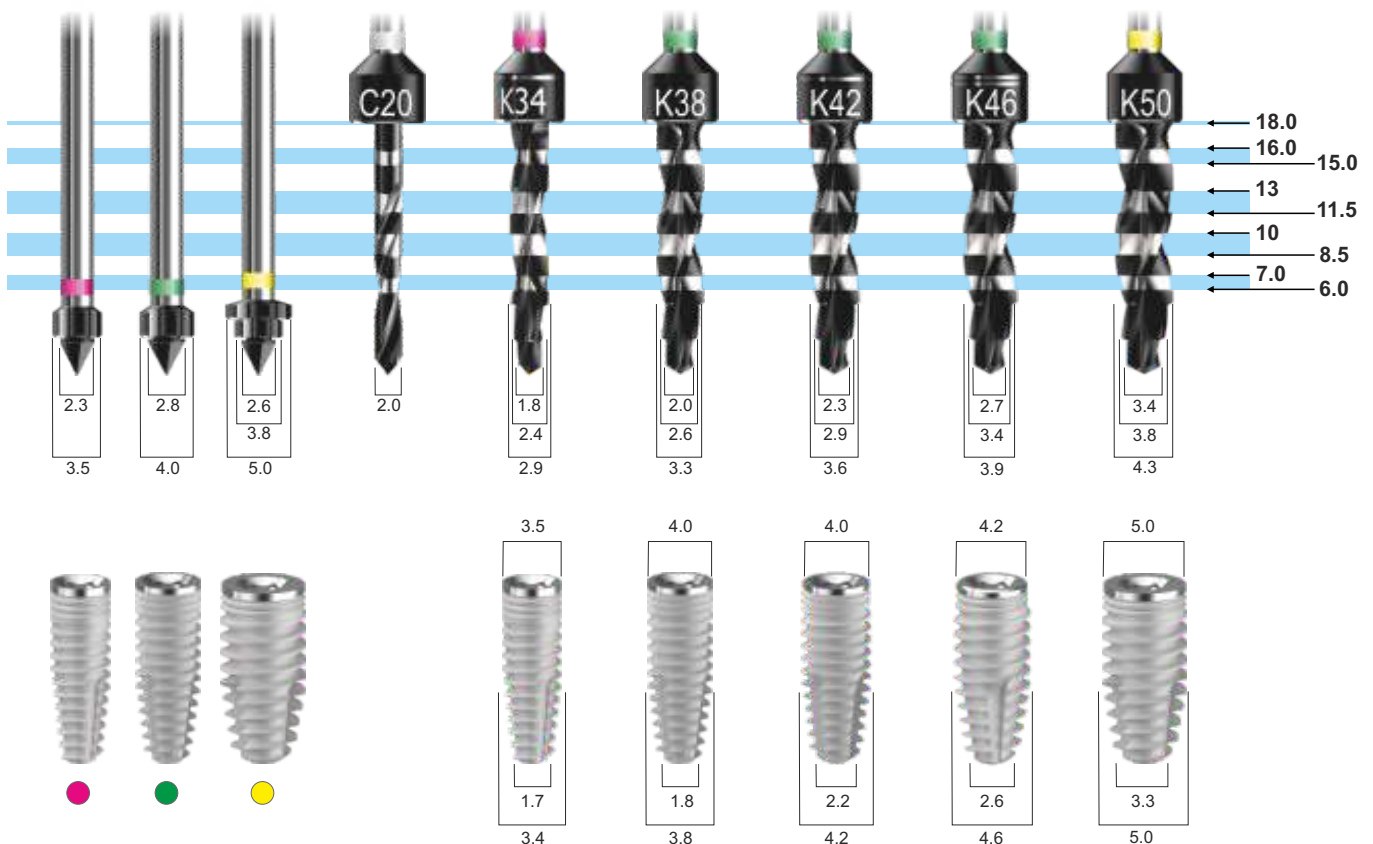

Various bio-mechanical factors affecting heat generation during osteotomy preparation: A systematic review

Chirag J Chauhan¹, Darshana N Shah¹, Foram B Sutaria¹

Indian J Dent Res. Jan-Feb 2018;29(1):81-92. doi: 10.4103/ijdr.IJDR_729_16.



LOGIC RELATION BETWEEN DRILL AND IMPLANT CORE

The rotary instruments design and shape is based on the logical coherence between the implants size, in the external dimensions, internal core and their penetration properties.

The **IC** line **Cylindrical Implants** have a tapered apical portion 3mm long.

The **IK** line **Conical Implants** have a tapered apical portion 5mm long.

The drills have respectively 2/3 apical sections, suitable for the implant tunnel preparation, with respect to the implant geometry, maintaining the best bone implant contact (BIC).

Each step drill is equipped with a sharp cutting edge to facilitate penetration, minimizing friction and overheating.

PRO MSD drilling technology

IL CONDIZIONAMENTO DEI PROTOCOLLI CHIRURGICI

Le geometrie implantari differenziate nella macro/micro forma, prevedono applicazioni diverse sia in funzione delle necessità chirurgico/protesiche (carico immediato, carico precoce o carico posticipato) sia in base alle condizioni della componente ossea/anatomica del paziente da riabilitare.

Tuttavia, si richiedono spesso indispensabili manovre chirurgiche e protocolli alternativi per migliorare le prestazioni implantari in funzione delle caratteristiche morfologiche delle strutture ossee residue.

La riuscita di tali manovre, come risultato di applicazioni combinate di strumenti e protocolli personalizzati, rappresenta la differente risposta al problema in relazione alle personali capacità operatorie ed alla presenza più o meno marcata di strumenti e mezzi adeguati all'applicazione delle stesse.

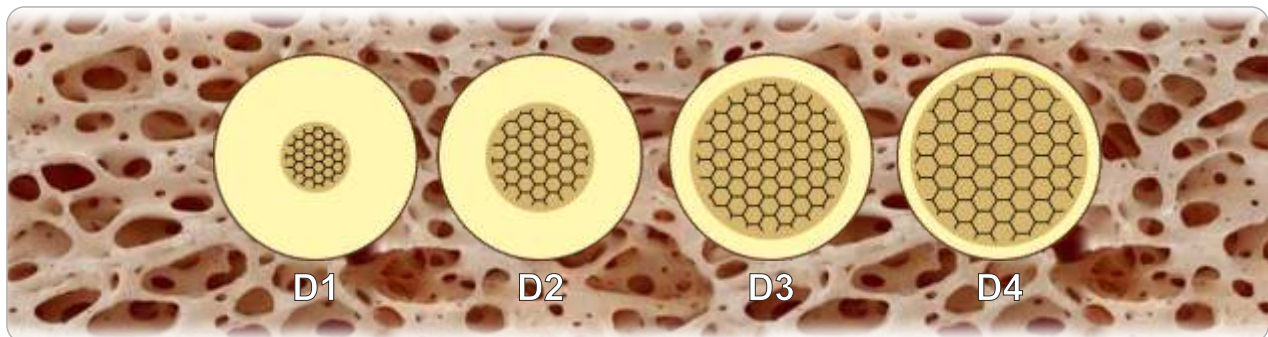

✓ Bone classification: clinical-histomorphometric comparison

Trisi P, Rao W. - Clin Oral Implants Res. 1999 Feb;10(1):1-7. doi: 10.1034/j.1600-0501.1999.100101.x.

OSSEODENSIFICAZIONE MECCANICA IN ROTAZIONE ANTIORARIA

L'osseodensificazione tramite strumenti rotanti è una recente tecnica chirurgica per la preparazione del sito implantare che può essere associata a differenti protocolli, applicabili in quelle particolari condizioni anatomiche dove la qualità ossea risulta scarsa e con dimensioni verticali / orizzontali insufficienti.

Questo approccio di osseo-condensazione osteotomica non sottrattiva, genera un aumento della densità ossea peri-osteotomica, con il risparmio del tessuto stesso e l'incremento della stabilità primaria implantare.



THE CONDITIONING OF SURGICAL PROTOCOLS

The differentiated implant geometries in the macro/micro shape provide for different applications, both according to the surgical/prosthetic requirements (immediate loading, early loading or postponed loading) and according to the conditions of the bone/anatomical component of the patient who needs rehabilitation. However, surgical maneuvers and alternative protocols are often required to improve implant performance, according to the morphological characteristics of the residual bone structures.

The success of these maneuvers, that is often the result of a customized tools and protocols combination, represents the different response to the problem in relation to the personal operating skills and the presence of tools suitable for their application.

MECHANICAL OSSEODENSIFICATION IN ANTI-CLOCKWISE ROTATION

The osseodensification using rotary instruments is a recent surgical technique for the implant site preparation that can be associated with different protocols; these protocols can be used in those particular anatomical conditions such as poor bone quality and insufficient vertical / horizontal dimensions.

This non-subtractive osteotomic bone-condensation approach produces an increase in peri-osteotomic bone density, saving the tissue and increasing the primary implant stability.

PRO MSD drilling technology

FRESE CHIRURGICHE RESISTA PRO MSD - Modular Surgical Drilling

Le Frese Chirurgiche Modulari a geometria variabile sono frese elicoidali a 3 sezioni con spoglia raggiata progressiva, utilizzabili in senso **orario** ed **antiorario**.

Il diametro di ogni fresa varia, con un rapporto costante, di 0,4mm (30/34/38/42/46/50), permettendo così all'operatore la scelta di utilizzo in funzione della qualità ossea (sovra-preparazione o sotto-preparazione).

Tutte le frese sono rivestite con un coating di lubrificante solido in diamante sintetico DLC (Diamond Like Carbon) che massimizza le prestazioni in termini di resistenza meccanica e riduzione dell'attrito.

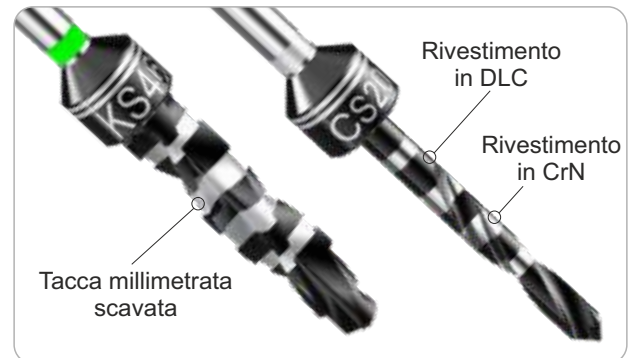
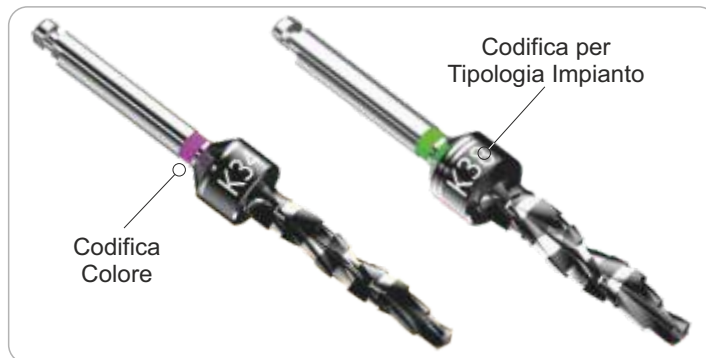

ROTAZIONE ANTIORARIA

La rotazione antioraria, invertendo le forze in gioco, genera 3 effetti differenti sulla pratica chirurgica di preparazione del tunnel implantare, che possono rivoluzionare la logica di fresatura conosciuta.

- 1) Spinta anteriore e laterale dell'osso asportato dalla punta più tutti i liquidi in gioco, sangue e fisiologica.
- 2) Espulsione ad "effetto martello" della fresa, con un miglioramento del controllo verticale.
- 3) Riduzione dell'efficienza di taglio a salvaguardia delle parti anatomiche sensibili.

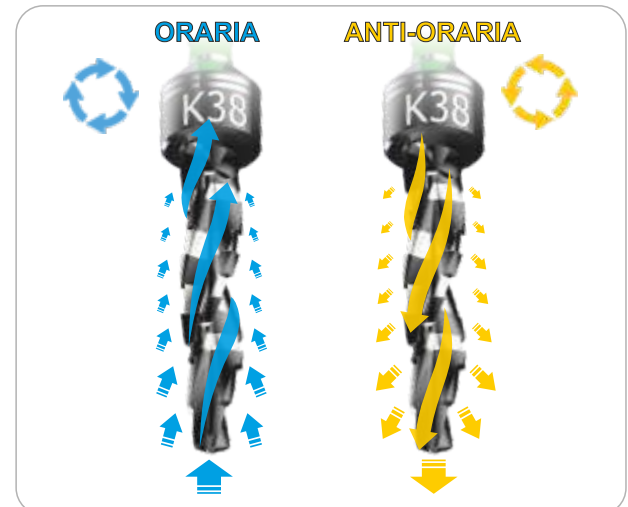

RESISTA PRO MSD SURGICAL DRILLS - Modular Surgical Drilling

The Modular Surgical Drills with variable geometry are 3-section helicoidal drills with progressive radius rake, that can be used clockwise and anticlockwise.

The diameter of each drill changes according to a constant ratio of 0.4mm (30/34/38/42/46/50): this allows the operator to choose the drill according to the bone quality (over-preparation or under-preparation). All the drills are coated with a DLC (Diamond Like Carbon) synthetic diamond solid lubricant that maximizes performance in terms of mechanical strength and friction reduction.

The **anticlockwise rotation**, reversing the involved forces, generates 3 different effects on the implant tunnel perforation, which can revolutionize the known milling logic.

- 1) Anterior and lateral thrust of the bone removed by the tip, and of the liquids as well, blood and physiological water.
- 2) Ejection and "hammer effect" of the drill that produce an improvement in vertical control.
- 3) Reduction of cutting efficiency to protect sensitive anatomical parts.

INTERNAL HEXAGON UNIVERSAL CONNECTION

ACTIVE BLADE SHAPE

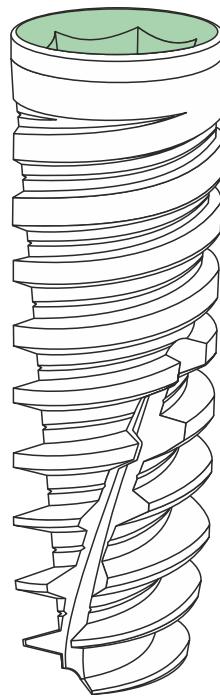

IA

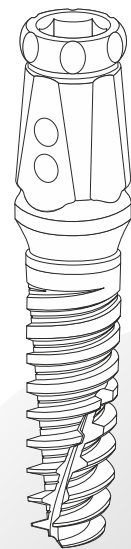

IMPIANTO
CON MOUNTER
WITH MOUNTER

IA 34

A-BLADE
internal hexagon - full treatment

ACTIVE BLADE SHAPE + MOUNTER

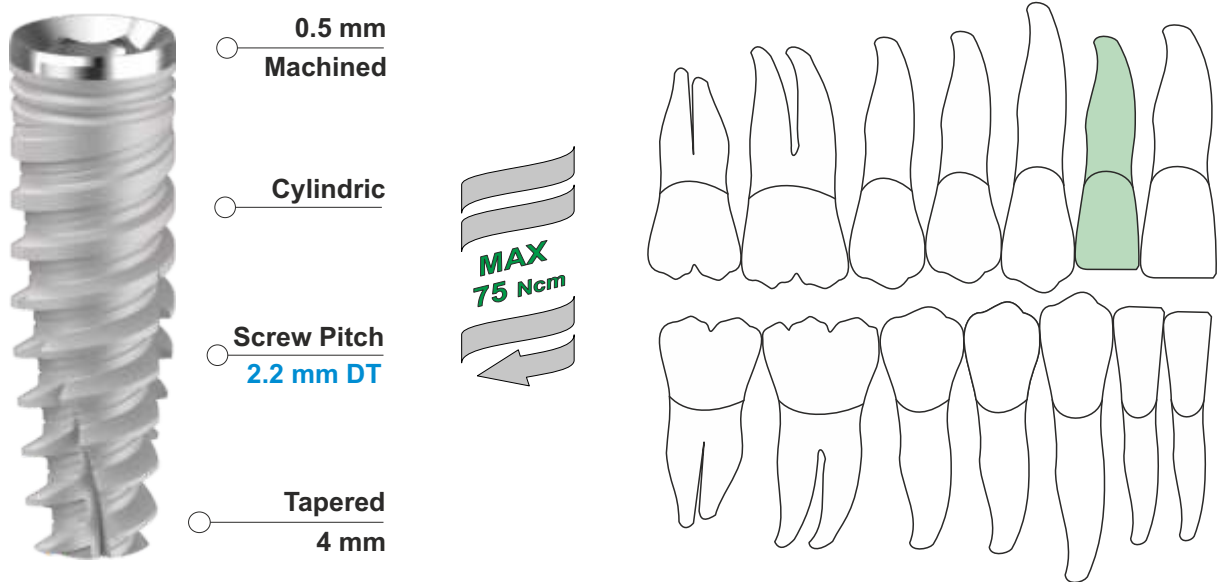

CODE	IMPLANT	LENGTH	PLATFORM	APEX
IA 3408	Ø 3.4	8.5 mm	Ø 3.5 CPS	Ø 1.8
IA 3410	Ø 3.4	10 mm	Ø 3.5 CPS	Ø 1.8
IA 3411	Ø 3.4	11.5 mm	Ø 3.5 CPS	Ø 1.8
IA 3413	Ø 3.4	13 mm	Ø 3.5 CPS	Ø 1.8

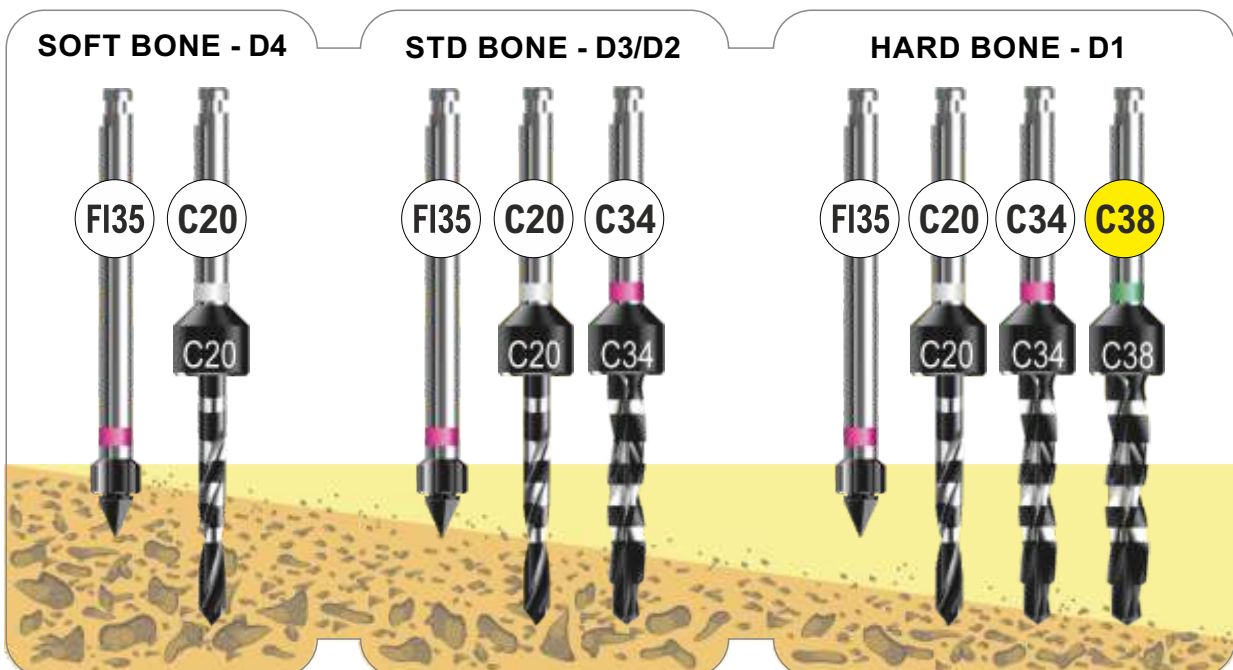

A-BLADE

internal hexagon - full treatment

IA 38

ACTIVE BLADE SHAPE + MOUNTER

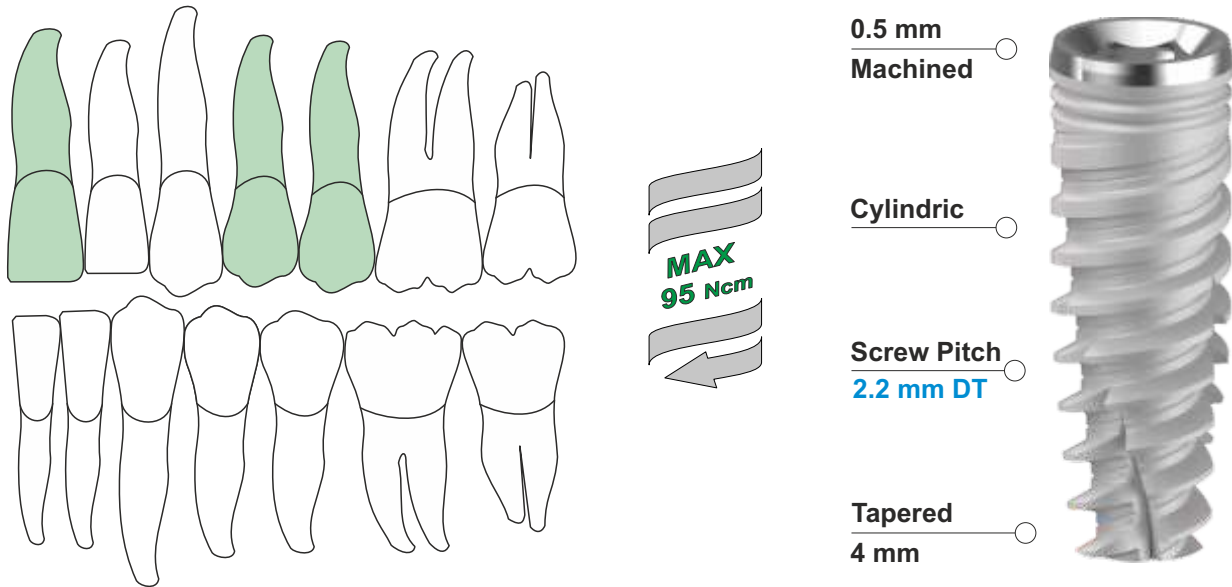

CODE	IMPLANT	LENGTH	PLATFORM	APEX
IA 3808	Ø 3.8	8.5 mm	Ø 4.0	Ø 2.1
IA 3810	Ø 3.8	10 mm	Ø 4.0	Ø 2.1
IA 3811	Ø 3.8	11.5 mm	Ø 4.0	Ø 2.1
IA 3813	Ø 3.8	13 mm	Ø 4.0	Ø 2.1
IA 3815	Ø 3.8	15 mm	Ø 4.0	Ø 2.1

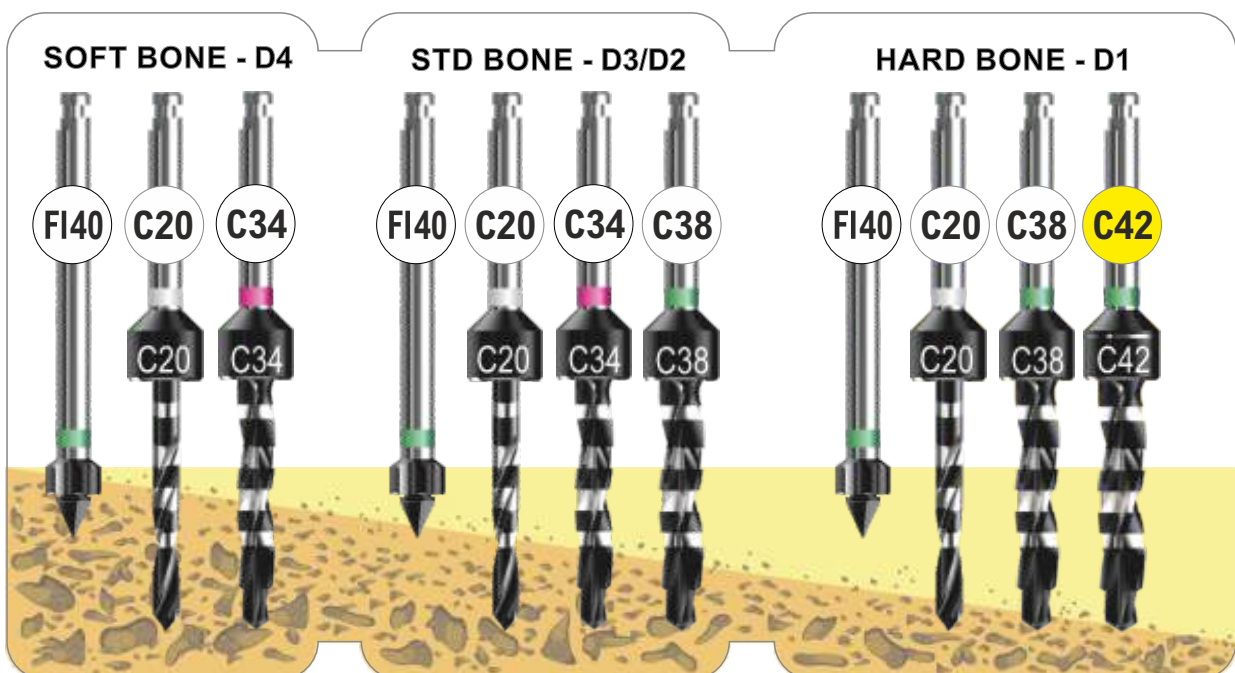

IA 42

A-BLADE
internal hexagon - full treatment

ACTIVE BLADE SHAPE + MOUNTER

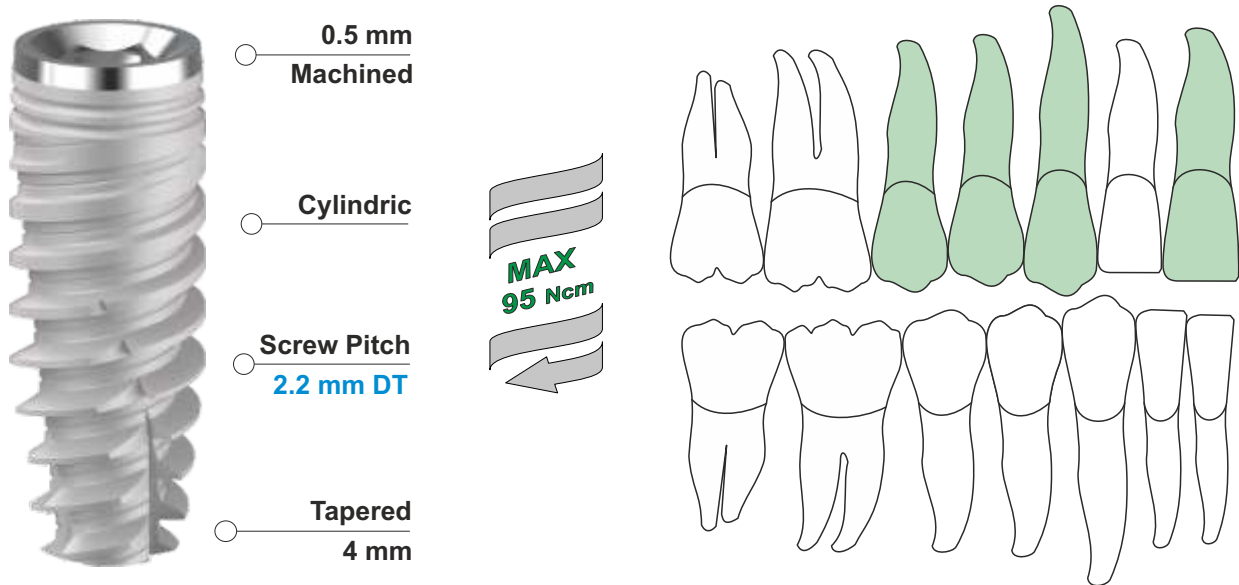

CODE	IMPLANT	LENGTH	PLATFORM	APEX
IA 4208	Ø 4.2	8.5 mm	Ø 4.0	Ø 2.5
IA 4210	Ø 4.2	10 mm	Ø 4.0	Ø 2.5
IA 4211	Ø 4.2	11.5 mm	Ø 4.0	Ø 2.5
IA 4213	Ø 4.2	13 mm	Ø 4.0	Ø 2.5
IA 4215	Ø 4.2	15 mm	Ø 4.0	Ø 2.5

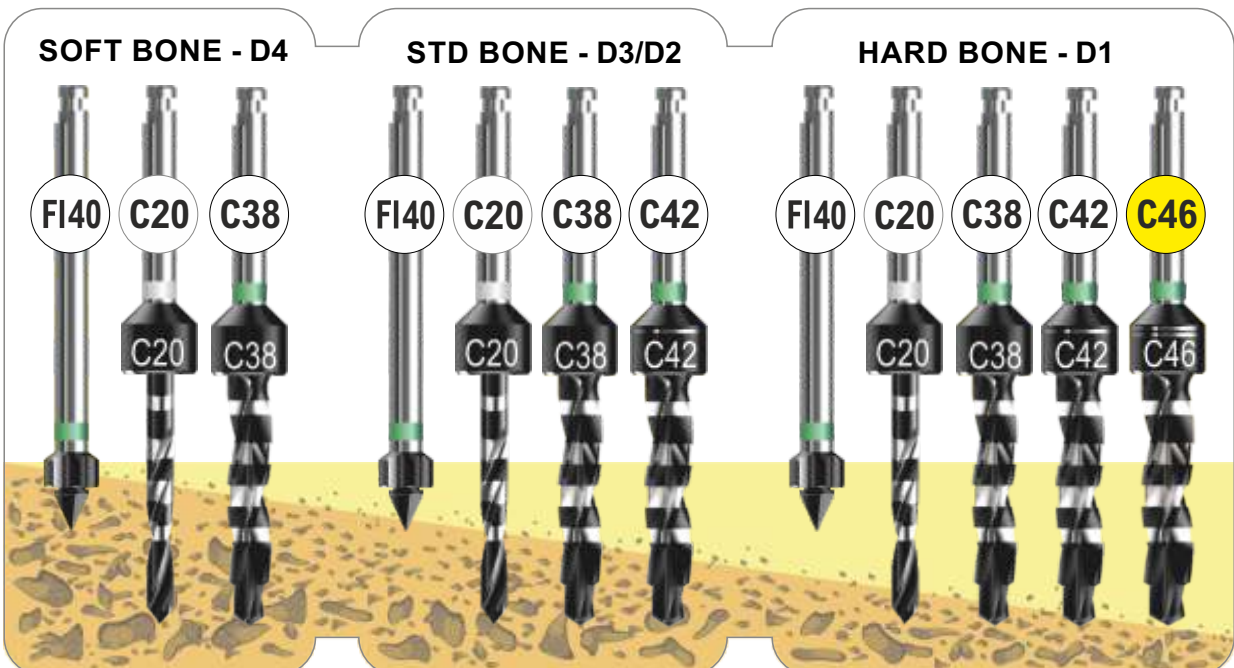

A-BLADE

internal hexagon - full treatment

IA 46

ACTIVE BLADE SHAPE + MOUNTER

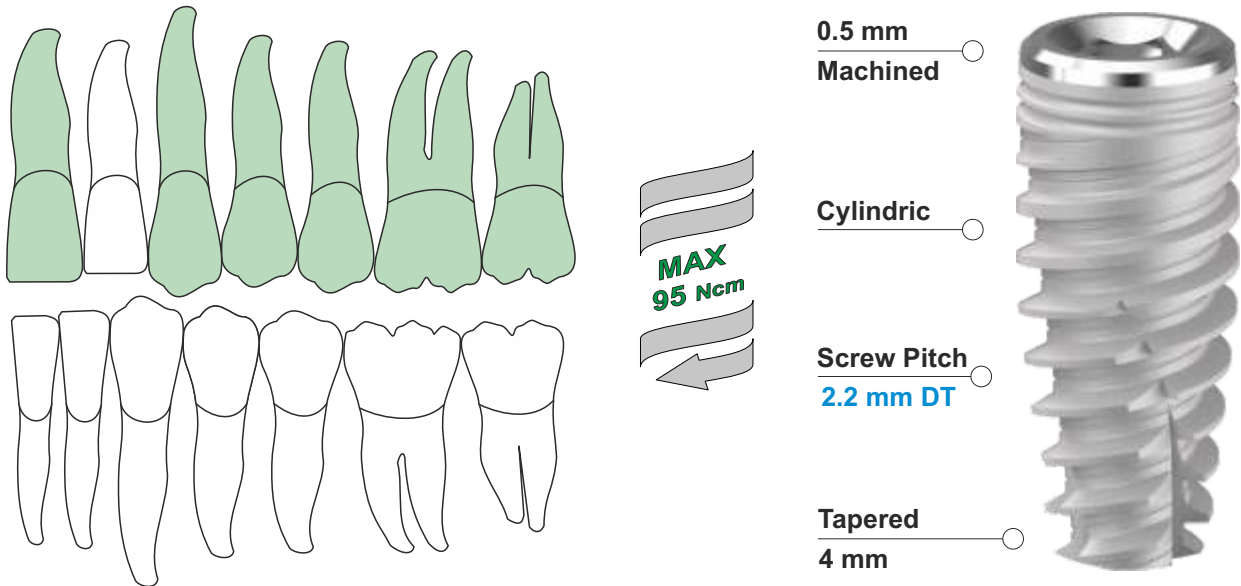

CODE	IMPLANT	LENGTH	PLATFORM	APEX
IA 4608	Ø 4.6	8.5 mm	Switch Ø 4.0	Ø 2.9
IA 4610	Ø 4.6	10 mm	Switch Ø 4.0	Ø 2.9
IA 4611	Ø 4.6	11.5 mm	Switch Ø 4.0	Ø 2.9
IA 4613	Ø 4.6	13 mm	Switch Ø 4.0	Ø 2.9
IA 4615	Ø 4.6	15 mm	Switch Ø 4.0	Ø 2.9

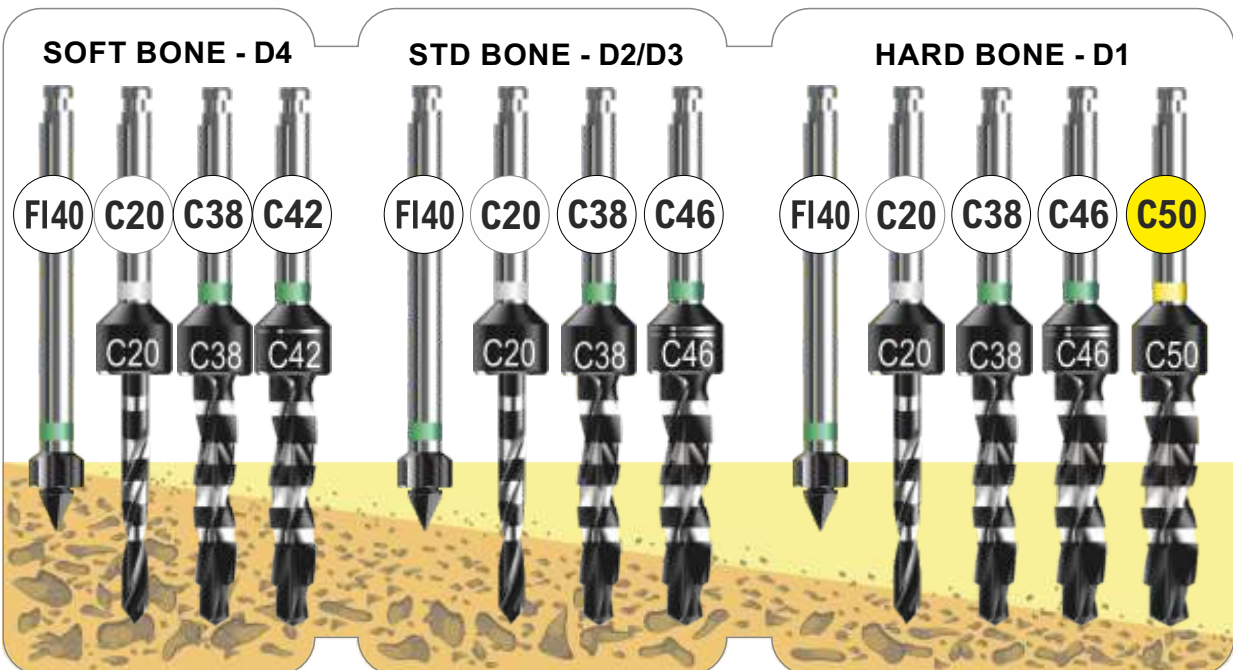

IA 50

A-BLADE
internal hexagon - full treatment

ACTIVE BLADE SHAPE + MOUNTER

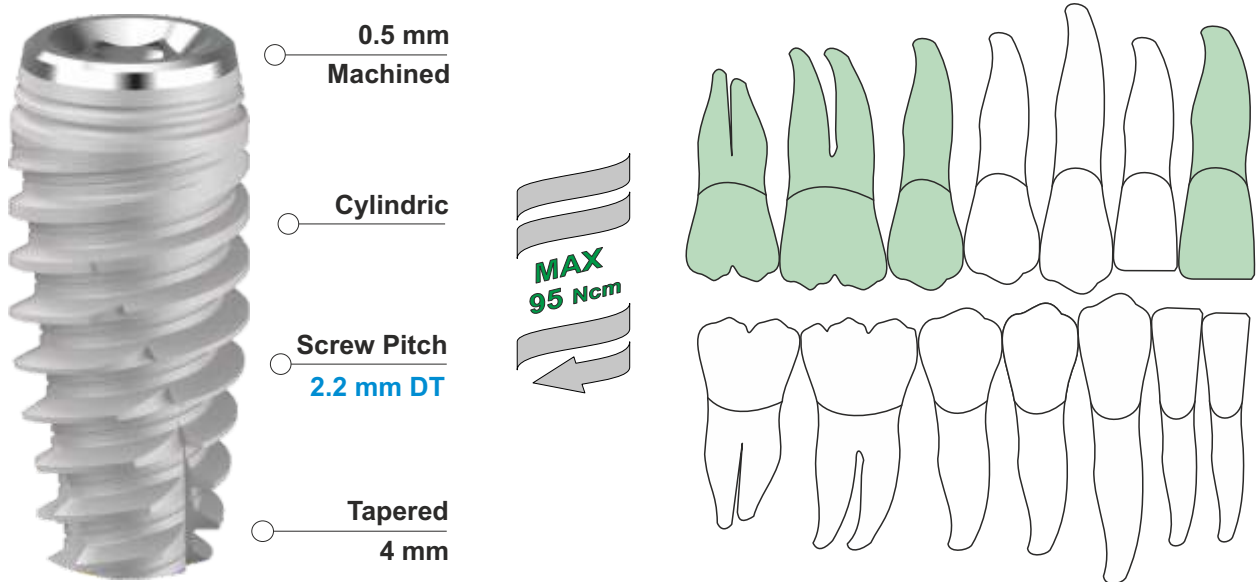

CODE	IMPLANT	LENGTH	PLATFORM	APEX
IA 5008	Ø 5.0	8.5 mm	Switch Ø 4.0	Ø 3.3
IA 5010	Ø 5.0	10 mm	Switch Ø 4.0	Ø 3.3
IA 5011	Ø 5.0	11.5 mm	Switch Ø 4.0	Ø 3.3
IA 5013	Ø 5.0	13 mm	Switch Ø 4.0	Ø 3.3

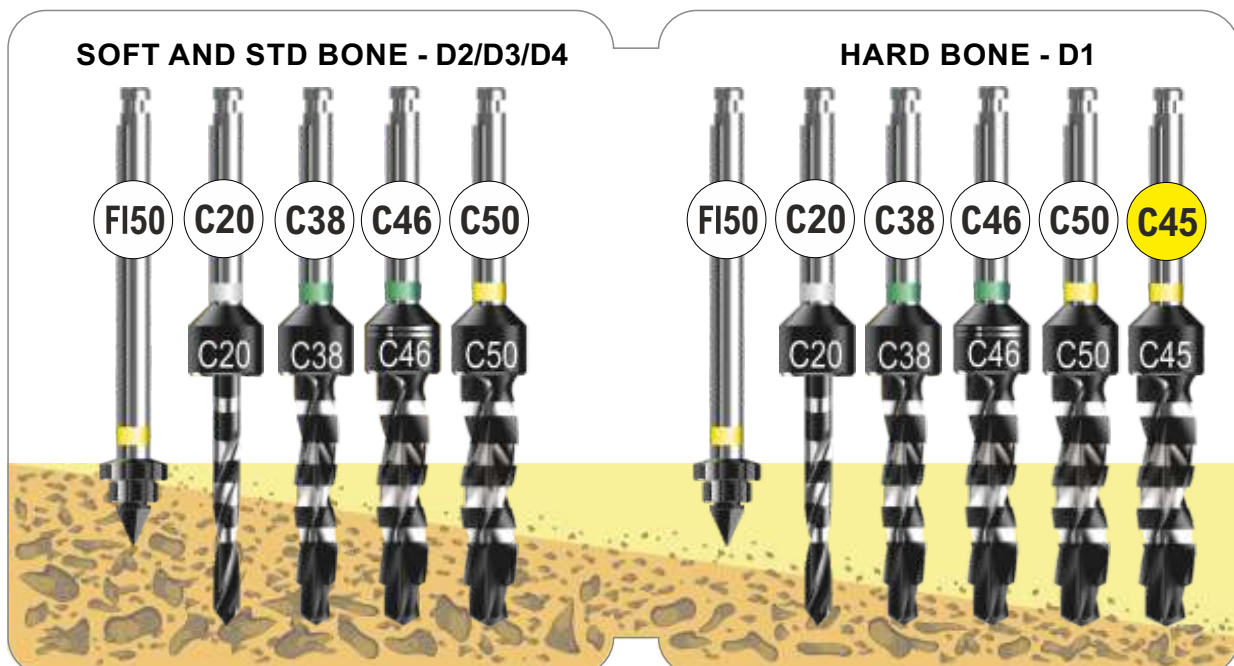

INTERNAL  HEXAGON
UNIVERSAL CONNECTION

UNIVERSAL
PROSTHETICS



universal prosthetics

20Ncm 



Pilastro di Guarigione CPS - Titanio Gr. 5 - Anodizzato
CPS Healing Abutment - Titanium Gr. 5 - Anodized

IP 4HA2-W H 2 mm - **CPS** Standard Gingival Profile
IP 4HA4-W H 4 mm - **CPS** Standard Gingival Profile
IP 4HA6-W H 6 mm - **CPS** Standard Gingival Profile

DM 1/2 Standard Hexagonal Driver Ø 1.27

20Ncm 



Pilastro di Guarigione FTF - Titanio Gr. 5 - Anodizzato
FTF Healing Abutment - Titanium Gr. 5 - Anodized

IP 4HA2 H 2 mm - **FTF** Standard Gingival Profile
IP 4HA4 H 4 mm - **FTF** Standard Gingival Profile
IP 4HA6 H 6 mm - **FTF** Standard Gingival Profile

DM 1/2 Standard Hexagonal Driver Ø 1.27

20Ncm 



Pilastro di Guarigione Largo FTF - Titanio Gr. 5 - Anodizzato
FTF Large Healing Abutment - Titanium Gr. 5 - Anodized

IP 4HA2-E H 2 mm - Large Gingival Profile
IP 4HA4-E H 4 mm - Large Gingival Profile
IP 4HA6-E H 6 mm - Large Gingival Profile

DM 1/2 Standard Hexagonal Driver Ø 1.27



Analogo per Laboratorio - Titanio Gr. 5 - Anodizzato
Laboratory Analog - Titanium Gr. 5 - Anodized

IP 4AL2DS-V H 12 mm - Universal Shape

32Ncm 



Moncone Calcinabile - Acrilico
Castable Abutment - Acrylic

IP 4CA-W Antirotation Hex - **CPS** Standard Gingival Profile
IP 4CR-W Rotating - **CPS** Standard Gingival Profile
IP 4CA Antirotation Hex - Standard Gingival Profile
IP 4CR Rotating - Standard Gingival Profile

IP VITG Vite di Ricambio Gold - Gold Spare Screw
DM 1/2 Standard Hexagonal Driver Ø 1.27

universal prosthetics

Pilastri Temporanei da Incollaggio - Titanio Gr. 5

Temporary Glueing Abutments - Titanium Gr. 5

IP 4TA-W Temporary Glueing Abutment - Antirotation Hex

IP 4TR-W Temporary Glueing Abutment - Rotating

IP VITG Vite di Ricambio Gold - Gold Spare Screw

DM 1/2 Standard Hexagonal Driver Ø 1.27



Pilastro Temporaneo da Saldatura - Titanio Gr. 5

Temporary Welding Abutments - Titanium Gr. 5

IP 4TRS Temporary Welding Abutment - Rotating

IP VITG Vite di Ricambio Gold - Gold Spare Screw

DM 1/2 Standard Hexagonal Driver Ø 1.27



Moncone Titanio Diritto - Titanio Gr. 5 - PVD TiN

Straight Titanium Abutment - Titanium Gr. 5 - PVD TiN

IP 4ST2-W 0° - Straight - **CPS** Standard Gingival Profile

IP VITG Vite di Ricambio Gold - Gold Spare Screw

DM 1/2 Standard Hexagonal Driver Ø 1.27



Moncone Titanio Angolato - Titanio Gr. 5 - PVD TiN

Angled Titanium Abutment - Titanium Gr. 5 - PVD TiN

IP 4AT15-W 15° - Angled - **CPS** Standard Gingival Profile

IP 4AT25-W 25° - Angled - **CPS** Standard Gingival Profile

IP VITG Vite di Ricambio Gold - Gold Spare Screw

DM 1/2 Standard Hexagonal Driver Ø 1.27



Moncone Titanio Diritto VPT - Titanio Gr. 5

VPT Straight Titanium Abutment - Titanium Gr. 5

IP 4STV-W 0° - Straight - **CPS** Standard Gingival Profile

IP VIT Vite di Ricambio - Spare Screw



DM 1/2 Standard Hexagonal Driver Ø 1.27



Vertical Preparation Technique

universal prosthetics

Moncone UCLA Cobalto Cromo - CoCr
UCLA Abutment Cobalt Chrome - CoCr



32Ncm  

IP 4CCA-W Antirotation Hex - **CPS Standard Gingival Profile**
IP 4CCR-W Rotating - **CPS Standard Gingival Profile**

Intervallo di Fusione 1350°-1430° Esp. Termica 13,3 - 13,6 µm/(m°C) (20°-200°)

IP VITG Vite di Ricambio Gold - Gold Spare Screw
DM 1/2 [Standard Hexagonal Driver Ø 1.27](#)

Moncone Provvisorio Estetico - PEEK Medica
Aesthetic Temporary Abutment - Medical PEEK

32Ncm  

IP 4PA Antirotation Hex - Standard Gingival Profile

IP VITG Vite di Ricambio Gold - Gold Spare Screw
DM 1/2 [Standard Hexagonal Driver Ø 1.27](#)

Pilastro a Sfera per Overdenture - Titanio Gr. 5 - PVD TiN
Overdenture Ball Abutment - Titanium Gr. 5 - PVD TiN

32Ncm  

IP 4BA1-W H 1 mm - **CPS Standard Gingival Profile - NORMO**
IP 4BA2-W H 2 mm - **CPS Standard Gingival Profile - NORMO**
IP 4BA3-W H 3 mm - **CPS Standard Gingival Profile - NORMO**
IP 4BA4-W H 4 mm - **CPS Standard Gingival Profile - NORMO**
IP 4BA6-W H 6 mm - **CPS Standard Gingival Profile - NORMO**

DM 1/2 [Standard Hexagonal Driver Ø 1.27](#)

Kit Pilastro Equator per Overdenture - Titanio Gr. 5 - PVD TiN
Overdenture Equator Abutment Kit - Titanium Gr. 5 - PVD TiN

32Ncm  

IP 4EQ1 H 1 mm - Narrow Gingival Profile
IP 4EQ2 H 2 mm - Narrow Gingival Profile
IP 4EQ3 H 3 mm - Narrow Gingival Profile
IP 4EQ4 H 4 mm - Narrow Gingival Profile
IP 4EQ5 H 5 mm - Narrow Gingival Profile

DM EQ [Squared Equator Driver](#)

universal prosthetics

Link per Incollaggio - TiB Compatible - Titanio Gr. 5

Bonding Technique Link - TiB Compatible - Titanium Gr. 5

IP 4STB Digital Titanium Link - Antirotation Hex

IP 4STB-W Digital Titanium Link - Antirotation Hex - **CPS**

IP VIT Vite di Ricambio - Spare Screw

DM 1/2 Standard Hexagonal Driver Ø 1.27



32Ncm

Link Standard per Incollaggio - Titanio Gr. 5

Standard Link for Bonding Technique - Titanium Gr. 5

IP 4SZB Analogical Titanium Link - Antirotation Hex

IP VIT Vite di Ricambio - Spare Screw

DM 1/2 Standard Hexagonal Driver Ø 1.27



32Ncm

Link Flat Digitale per Incollaggio - Titanio Gr. 5

Flat Digital Link for Bonding Technique - Titanium Gr. 5

IP 5TB DS Flat Titanium Link - Antirotation Hex - Ø4mm

IP 5TBR DS Flat Titanium Link - Rotating - Ø4mm

IP VIT Vite di Ricambio - Spare Screw

DM 1/2 Standard Hexagonal Driver Ø 1.27



32Ncm

Monconi Estetici - Zirconia + Link in Titanio Gr. 5

Titanium Abutment - Zirconium + Titanium Gr. 5 Link

IP 4SZ 0° - Straight - Standard Gingival Profile

IP 4AZ15 15° - Angled - Standard Gingival Profile

IP VITG Vite di Ricambio Gold - Gold Spare Screw

DM 1/2 Standard Hexagonal Driver Ø 1.27



32Ncm

Transfer per impronta Pick Up - Titanio Gr. 5

Pick Up Impression Coping - Titanium Gr. 5

IP X40-W H 12mm - Internal Hexagon CPS

DM 1/2 Standard Hexagonal Driver Ø 1.27



25Ncm

Tubetto con Esagono

Vite Lunga

double connection friction fit 1.5°

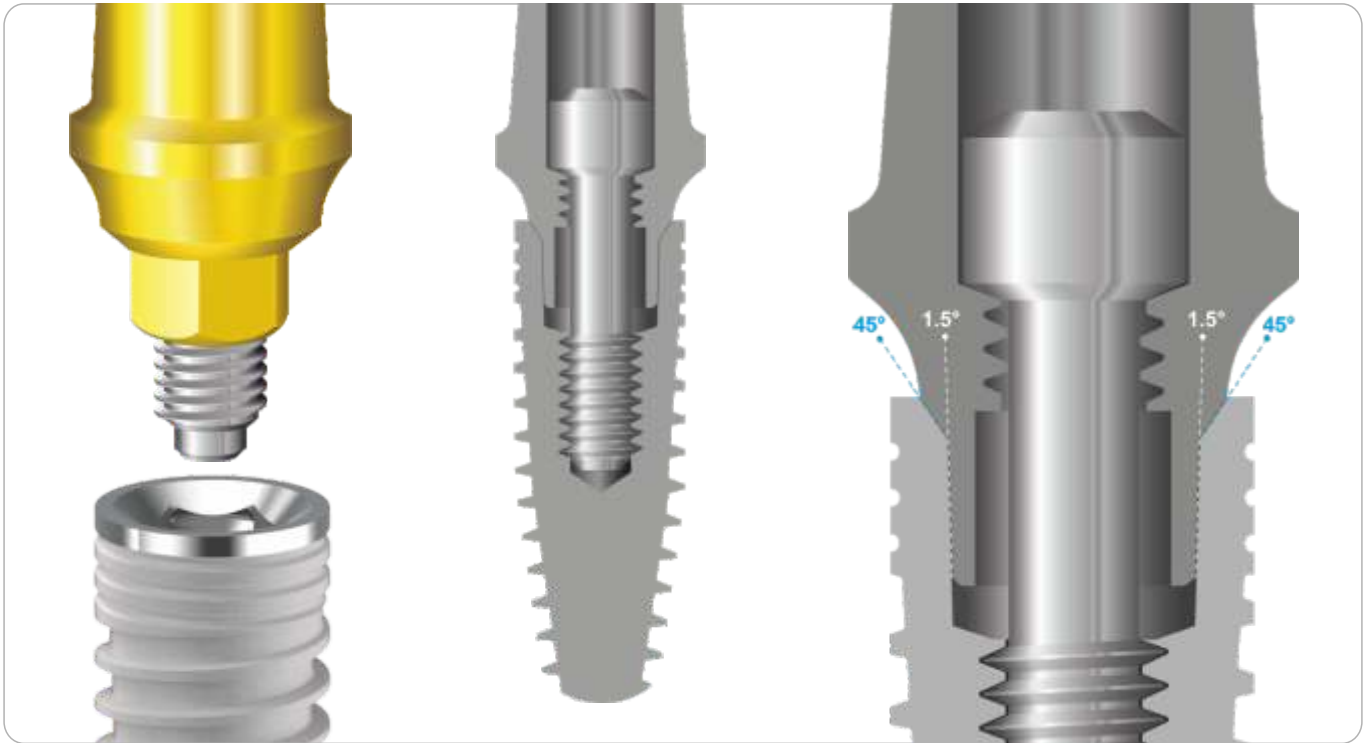

32Ncm 



Moncone Titanio Dritto - Titanio Gr. 5 - PVD TiN

Straight Titanium Abutment - Titanium Gr. 5 - PVD TiN

- IP 4ST2-WF** 0° - Straight H2mm - **CPS** Friction Fit
- IP 4ST3-WF** 0° - Straight H3.5mm - **CPS** Friction Fit
- IP 5ST2-F** 0° - Straight H2mm (Large) - **FTF** Friction Fit

IP VITG Vite di Ricambio Gold - Gold Spare Screw
DM 1/2 Standard Hexagonal Driver Ø 1.27

32Ncm 



Moncone in Titanio Angolato 15° - Titanio Gr. 5 - PVD TiN

15° Angled Titanium Abutment - Titanium Gr. 5 - PVD TiN

- IP 4AT152-WF** 15° Angled H2mm - **CPS** Friction Fit
- IP 4AT153-WF** 15° Angled H3mm - **CPS** Friction Fit
- IP 5ST152-F** 15° - Angled H2mm (Large) - **FTF** Friction Fit

IP VITG Vite di Ricambio Gold - Gold Spare Screw
DM 1/2 Standard Hexagonal Driver Ø 1.27

32Ncm 



Moncone in Titanio Angolato 25° - Titanio Gr. 5 - PVD TiN

25° Angled Titanium Abutment - Titanium Gr. 5 - PVD TiN

- IP 4AT252-WF** 25° Angled H2mm - **CPS** Friction Fit
- IP 4AT253-WF** 25° Angled H3mm - **CPS** Friction Fit
- IP 5ST252-F** 25° - Angled H2mm (Large) - **FTF** Friction Fit

IP VITG Vite di Ricambio Gold - Gold Spare Screw
DM 1/2 Standard Hexagonal Driver Ø 1.27

double connection friction fit 1.5°

CHIUSURA A SPALLA CONICA 45°

L'appoggio protesico interno a 45°, già utilizzato nelle connessioni interne tipo Zimmer dagli anni 90, oltre ad avere un supporto bibliografico indiscutibile, garantisce la distribuzione delle forze vettoriali che minimizzano il momento flettente laterale.

Questa tipologia di appoggio conico, normalmente utilizzata nella meccanica di distribuzione, rispetto ad uno piano, incrementa la superficie di contatto e scarica le forze su una curva di vettori multi-direzionali.

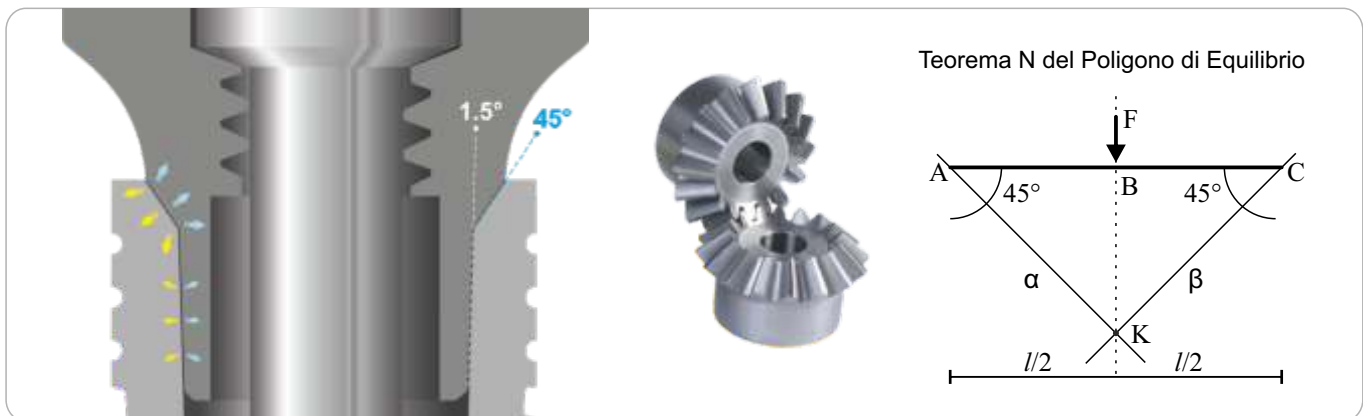

CONNESSIONE ESAGONALE CONICA FRICTION FIT 1.5°

La conicità di 1.5° sulle pareti piane dell'esagono maschio/femmina determina una riduzione dell'interfaccia meccanica così intima da conferire un grippaggio diretto, conosciuto come «saldatura a freddo», tra abutment ed impianto.

Questo effetto si attiva completamente alla fine del serraggio protesico della vite passante, raggiungendo i 30 Ncm di forza torcente che garantisce il sigillo batterico riducendo a zero il gap di interfaccia.

Per la rimozione dell'abutment sarà necessario l'utilizzo di una vite di rimozione alternativa, da avvitare in sostituzione di quella originale, con la sola funzione di spingere dall'interno verticalmente il moncone e rimuoverlo dalla sua posizione grippata.



45° CONICAL SHOULDER CLOSURE

The 45° internal prosthetic support, already used in internal Zimmer type connections since the 90s, has an indisputable bibliography and moreover guarantees the distribution of vector forces that minimize the lateral bending moment.

This type of conical support, normally used in the distribution mechanics, increases the contact surface in relation to a plane surface and releases the forces on a curve of multi-directional vectors.

FRICTION FIT 1.5° CONICAL HEX CONNECTION

The 1.5° conicity on the flat surfaces of the male / female hexagon causes a so close reduction of the mechanical interface that confers a direct binding (known as "cold welding") between the abutment and the implant.

This effect is fully activated at the end of the prosthetic tightening of the passing screw, that reaches 30 Ncm of torque and guarantees a bacterial seal through the reduction of the interface gap to zero.

In order to remove the abutment it will be necessary to use an alternative removal screw, that needs to be screwed in the original one place: its unique function is to push the abutment from the inside vertically and to remove it from its bound position.

25Ncm 



Transfer per Impronta Digitale - Titanio Gr. 5 + MS

Scan Abutment - Titanium Gr. 5 + Micro Sandblasting

IP 4SA2 DS Antirotation Hex - **Narrow** Gingival Profile

DM 1/2

Standard Hexagonal Driver Ø 1.27



Analogo CAD da Laboratorio con Vite - Titanio Gr. 5

Laboratory CAD Analog with Screw - Titanium Gr. 5

IP 4AL2 DS Antirotation Hex - Ø 4 Universal Shape

DM 1/2

Standard Hexagonal Driver Ø 1.27

32Ncm 

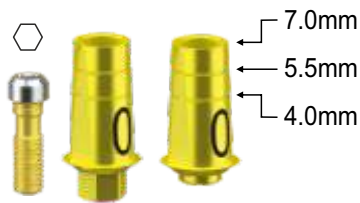

Adjustable in 3 heights

Link Base per Incollaggio - Titanio Gr. 5

Bonding Technique Base Link - Titanium Gr. 5

IP 4TB0 DS-W Gingival Profile **H 0.3mm** - Antirotation Hex

IP 4TBR0 DS-W Gingival Profile **H 0.3mm** - Rotanting

IP VITG

Vite di Ricambio Gold - Gold Spare Screw

DM 1/2

Standard Hexagonal Driver Ø 1.27

32Ncm 

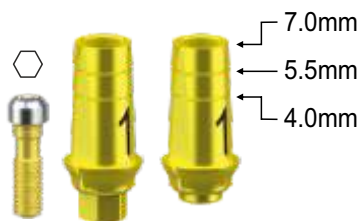

Adjustable in 3 heights

Link Base per Incollaggio - Titanio Gr. 5

Bonding Technique Base Link - Titanium Gr. 5

IP 4TB1 DS-W Gingival Profile **H 1.5mm** - Antirotation Hex

IP 4TBR1 DS-W Gingival Profile **H 1.5mm** - Rotanting

IP VITG

Vite di Ricambio Gold - Gold Spare Screw

DM 1/2

Standard Hexagonal Driver Ø 1.27

32Ncm 

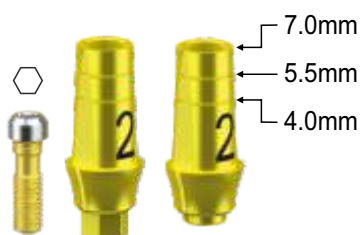

Adjustable in 3 heights

Link Base per Incollaggio - Titanio Gr. 5

Bonding Technique Base Link - Titanium Gr. 5

IP 4TB2 DS-W Gingival Profile **H 2.5mm** - Antirotation Hex

IP 4TBR2 DS-W Gingival Profile **H 2.5mm** - Rotanting

IP VITG

Vite di Ricambio Gold - Gold Spare Screw

DM 1/2

Standard Hexagonal Driver Ø 1.27

toronto universal prosthetics

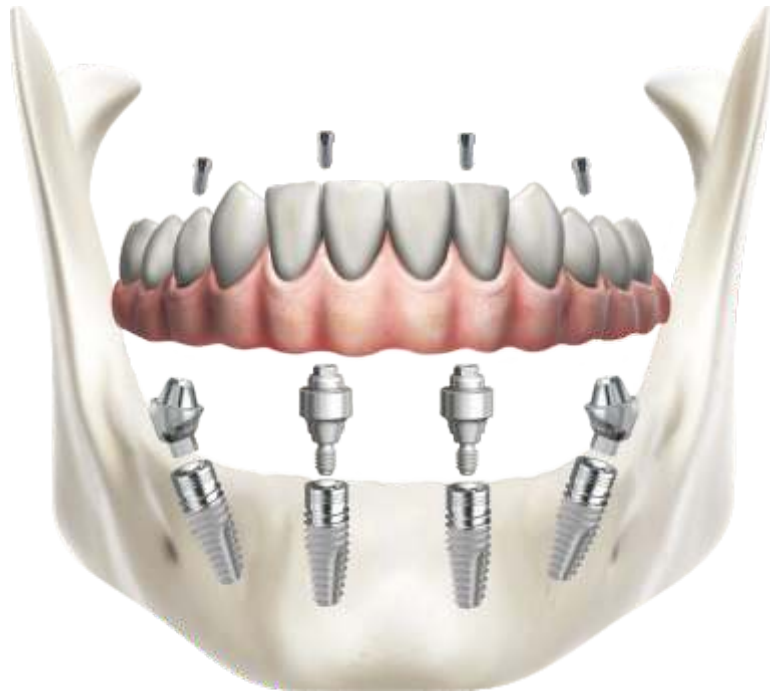

Pilastro Toronto Dritto - Titanio Gr. 5

Toronto Straight Abutment - Titanium Gr. 5

- IP MS1-W H 1 mm - CPS Standard Gingival Profile
- IP MS2-W H 2 mm - CPS Standard Gingival Profile
- IP MS3-W H 3 mm - CPS Standard Gingival Profile

DCDM Toronto Straight Abutment Driver



Pilastro Toronto Angolato 17° - Titanio Gr. 5

17° Toronto Angled Abutment - Titanium Gr. 5

- IP MA172-W 17° - H 2 mm - CPS Standard Gingival Profile
- IP MA173-W 17° - H 3 mm - CPS Standard Gingival Profile

IP VITMA Vite di Ricambio Toronto - Toronto Spare Screw
DMX 1/2 Standard Torx Driver



Pilastro Toronto Angolato 30° - Titanio Gr. 5

30° Toronto Angled Abutment - Titanium Gr. 5

- IP MA303-W 30° - H 3 mm - CPS Standard Gingival Profile
- IP MA304-W 30° - H 4 mm - CPS Standard Gingival Profile
- IP MA305-W 30° - H 5 mm - CPS Standard Gingival Profile

IP VITMA Vite di Ricambio Toronto - Toronto Spare Screw
DMX 1/2 Standard Torx Driver



toronto universal prosthetics

15Ncm 



Pilastro Temporaneo Toronto - Titanio Gr. 5

Toronto Temporary Abutment - Titanium Gr. 5

EP MT Rotating - Bonding Technique - Incollaggio Passivo

EP MV Vite di Ricambio Toronto - Toronto Spare Screw

DMX 1/2 Standard Torx Driver

15Ncm 





Pilastro Temporaneo Toronto - Titanio Gr. 5

Toronto Temporary Abutment - Titanium Gr. 5

EP MTS Rotating - Welding Technique - Saldatura Intraorale

EP MV Vite di Ricambio Toronto - Toronto Spare Screw

DMX 1/2 Standard Torx Driver

10Ncm 



Pilastro Calcinabile Toronto - Acrilico

Toronto Castable Abutment - Acrylic

EP MC Rotating - Standard Gingival Profile

EP MV Vite di Ricambio Toronto - Toronto Spare Screw

DMX 1/2 Standard Torx Driver

15Ncm 



Pilastro di Guarigione Toronto

Toronto Healing Abutment

EP MHA H 4 mm - Standard Gingival Profile Titanium Gr5

EP MHA6 H 6 mm - Large Gingival Profile Titanium Gr5

DMX 1/2 Standard Torx Driver

15Ncm 



Transfer Toronto - Titanio Gr. 5

Toronto Impression Coping - Titanium Gr. 5

EP MI Rotating - Standard Gingival Profile

EP MVL Vite di Ricambio Toronto L - Toronto L Spare Screw

DMX 1/2 Standard Torx Driver

toronto universal prosthetics

Viti di Ricambio Toronto - Titanio Gr. 5

Toronto Spare Screws - Titanium Gr. 5

EP MV Prosthetic Spare Screw
EP MVL Impression Spare Screw

DMX 1/2 Standard Torx Driver



Analogo Toronto - Titanio Gr. 5

Toronto Analog - Titanium Gr. 5

EP MAL2DS-V H 10 mm - Universal Shape



CPS Cover Screw - Potenza GBR e GTR

GTR - Incremento di gengiva aderente



GBR - Recupero facilitato della Cover Screw





Vite Chirurgica di Copertura CPS - Titanio Gr. 4

CPS Cover Screw - Titanium Gr. 4

IP 4CS1 CPS Cover Screw - 1.5mm
IP 4CS3 CPS Cover Screw - 3.0mm
IP 4CS5 CPS Cover Screw - 5.0mm

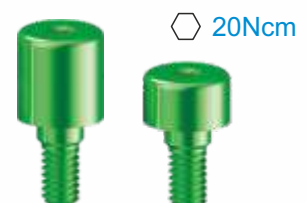
DM 1/2 Standard Hexagonal Driver Ø 1.27





Transfer Toronto per Impronta Digitale - Titanio Gr. 5
Toronto Scan Abutment - Titanium Gr. 5

15Ncm 

EP MSA2 DS Rotating Scan Abutment - Transfer Digitale Rotante

EP MV Vite di Ricambio Toronto - Toronto Spare Screw
DMX 1/2 Standard Torx Driver

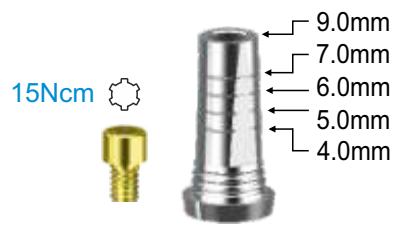

Link Base per Incollaggio - Titanio Gr. 5
 Bonding Technique Base Link - Titanium Gr. 5

15Ncm 

9.0mm
 7.0mm
 6.0mm
 5.0mm
 4.0mm

EP MT DS Rotating - Bonding Technique - Incollaggio Passivo

EP MV Vite di Ricambio Toronto - Toronto Spare Screw
DMX 1/2 Standard Torx Driver

Adjustable in 5 heights



Analogo Toronto per Laboratorio - Titanio Gr. 5
Laboratory Toronto Analog - Titanium Gr. 5

EP MAL2DS Universal Toronto Analog

DM 1/2 Standard Hexagonal Driver Ø 1.27



CPS Conical Platform Switching

- 1 PIANA - flat to flat
- 2 CONICA 45°

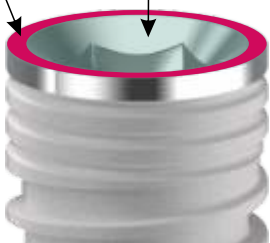

CONNESSIONE CPS RESISTA

La connessione esagonale interna CPS prevede un doppia possibilità di protesizzazione che meglio si adatta alle differenti scuole di pensiero protesico.

1 La piattaforma esterna piana (flat to flat) è ideale per le soluzioni protesiche multi-impianto solidarizzate ed avvitate (tipo Toronto).

2 La piattaforma interna conica 45° (platform switching) è ideale per le soluzioni protesiche singole avvitate testa impianto o cementate su abutment singoli/multipli (ponti e corone).

FTF



CPS



NARROW



CPS
COVER SCREW



VARIANTI DI CHIUSURA PROTESICA E PROFILO EMERGENTE

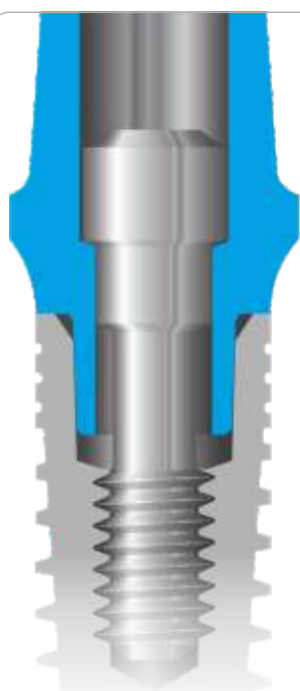

FTF - PIANA

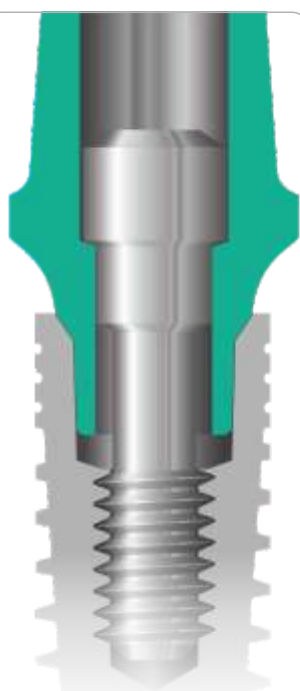

CPS - CONICA



NARROW - PIANA

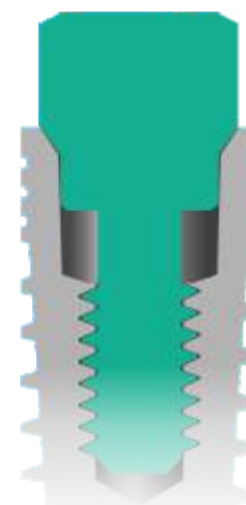

COVER CREW - CPS

INTERNAL  HEXAGON
WIDE CONNECTION

WIDE
PROSTHETICS



wide prosthetics

20Ncm 



Pilastro di Guarigione - Titanio Gr. 5 - Anodizzato

Healing Abutment - Titanium Gr. 5 - Anodized

IP 5HA3 H 3 mm - Large Gingival Profile

IP 5HA5 H 5 mm - Large Gingival Profile

DM 1/2

Standard Hexagonal Driver Ø 1.27



Analogo per Laboratorio - Titanio Gr. 5 - Anodizzato

Laboratory Analog - Titanium Gr. 5 - Anodized

IP 5AL2DS-V H 12 mm - Universal Shape

32Ncm 



Moncone Calcinabile - Acrilico

Castable Abutment - Acrylic

IP 5CA Antirotação Hex - Large Gingival Profile

IP 5CR Rotating - Large Gingival Profile

IP VITG Vite di Ricambio Gold - Gold Spare Screw

DM 1/2

Standard Hexagonal Driver Ø 1.27



32Ncm 

Monconi in Titanio - Titanio Gr. 5 - PVD TiN

Titanium Abutments - Titanium Gr. 5 - PVD TiN

IP 5ST3 0° - Straight - Large Gingival Profile

IP 5AT15 15° - Angled - Large Gingival Profile

IP 5AT25 25° - Angled - Large Gingival Profile

IP VITG Vite di Ricambio Gold - Gold Spare Screw

DM 1/2

Standard Hexagonal Driver Ø 1.27

32Ncm 



Moncone Ucla Oro - Base Oro/Platino/Iridio

Ucla Gold Abutment - Gold/Platinum/Iridium Base

IP 5GA Antirotação Hex - Large Gingival Profile

IP VITG Vite di Ricambio Gold - Gold Spare Screw

DM 1/2

Standard Hexagonal Driver Ø 1.27

wide prosthetics

Pilastrini Temporanei - Titanio Gr. 5

Temporary Abutments - Titanium Gr. 5

IP 4TA-W Temporary Glueing Abutment - Antirotation Hex

IP 4TR-W Temporary Glueing Abutment - Rotating

IP 4TRS Temporary Welding Abutment - Rotating

IP VITG Vite di Ricambio Gold - Gold Spare Screw

DM 1/2 Standard Hexagonal Driver Ø 1.27

Glueing

Welding



 32Ncm



Moncone UCLA Cobalto Cromo - CoCr

UCLA Abutment Cobalt Chrome - CoCr

IP 4CCA Antirotation Hex - Standard Gingival Profile

IP 4CCA-W Antirotation Hex - **Waisted** Gingival Profile CPS

IP VITG Vite di Ricambio Gold - Gold Spare Screw

DM 1/2 Standard Hexagonal Driver Ø 1.27



 32Ncm



Moncone Provvisorio Estetico - PEEK Medicale

Aesthetic Temporary Abutment - Medical PEEK

IP 5PA Antirotation Hex - Large Gingival Profile

IP VITG Vite di Ricambio Gold - Gold Spare Screw

DM 1/2 Standard Hexagonal Driver Ø 1.27



 32Ncm



Moncone Estetico - Zirconia + Link in Titanio Gr. 5

Aesthetic Abutment - Zirconium + Titanium Gr. 5 Link

IP 5SZ 0° - Straight - Large Gingival Profile

IP 5AZ15 15° - Angled - Large Gingival Profile

IP VITG Vite di Ricambio Gold - Gold Spare Screw

DM 1/2 Standard Hexagonal Driver



 32Ncm



Transfer per impronta Pick Up - Titanio Gr. 5

Pick Up Impression Coping - Titanium Gr. 5

IP X50 H 12mm - Internal Hexagon

DM 1/2 Standard Hexagonal Driver



 25Ncm

wide prosthetics

Pilastro a Sfera per Overdenture - Titanio Gr. 5 - PVD TiN

Overdenture Ball Abutment - Titanium Gr. 5 - PVD TiN

32Ncm 



IP 4BA1-W H 1 mm - **CPS** Standard Gingival Profile - NORMO

IP 4BA2-W H 2 mm - **CPS** Standard Gingival Profile - NORMO

IP 4BA3-W H 3 mm - **CPS** Standard Gingival Profile - NORMO

IP 4BA4-W H 4 mm - **CPS** Standard Gingival Profile - NORMO

IP 4BA6-W H 6 mm - **CPS** Standard Gingival Profile - NORMO

DM 1/2 [Standard Hexagonal Driver](#)

Kit Pilastro Equator per Overdenture - Titanio Gr. 5 - PVD TiN

Overdenture Equator Abutment Kit - Titanium Gr. 5 - PVD TiN

32Ncm 



IP 4EQ1 H 1 mm - Narrow Gingival Profile

IP 4EQ2 H 2 mm - Narrow Gingival Profile

IP 4EQ3 H 3 mm - Narrow Gingival Profile

IP 4EQ4 H 4 mm - Narrow Gingival Profile

IP 4EQ5 H 5 mm - Narrow Gingival Profile

DMEQ [Squared Equator Driver](#)

Digital Solutions

Transfer per Impronta Digitale - Titanio Gr. 5 + MS

Scan Abutment - Titanium Gr. 5 + Micro Sandblasting

IP 4SA2 DS Antirotaion Hex - **Narrow** Gingival Profile

IP VIT Vite di Ricambio - Spare Screw

25Ncm 



Link Flat Digitale per Incollaggio - Titanio Gr. 5

Flat Digital Link for Bonding Technique - Titanium Gr. 5

IP 5TB DS Flat Titanium Link - Antirotaion Hex - Ø4mm

IP 5TBR DS Flat Titanium Link - Rotating - Ø4mm

IP VITG Vite di Ricambio Gold - Gold Spare Screw

DM 1/2 [Standard Hexagonal Driver Ø 1.27](#)

32Ncm 



Analogo Digitale per Laboratorio - Titanio Gr. 5 - Anodizzato

Laboratory Digital Analog - Titanium Gr. 5 - Anodized

IP 5AL2DS H 12 mm - Universal Shape



toronto universal prosthetics

Pilastro Toronto Dritto - Titanio Gr. 5

Toronto Straight Abutment - Titanium Gr. 5

IP MS1-W H 1 mm - Standard Gingival Profile

IP MS2-W H 2 mm - Standard Gingival Profile

IP MS3-W H 3 mm - Standard Gingival Profile

DCDM Toronto Straight Abutment Driver



Pilastro Toronto Angolato 17° - Titanio Gr. 5

17° Toronto Angled Abutment - Titanium Gr. 5

IP MA172-W 17° - H 2 mm - Standard Gingival Profile

IP MA173-W 17° - H 3 mm - Standard Gingival Profile

IP VITMA Vite di Ricambio Toronto - Toronto Spare Screw

DMX 1/2 Standard Torx Driver



Pilastro Toronto Angolato 30° - Titanio Gr. 5

30° Toronto Angled Abutment - Titanium Gr. 5

IP MA303-W 30° - H 3 mm - Standard Gingival Profile

IP MA304-W 30° - H 4 mm - Standard Gingival Profile

IP MA305-W 30° - H 5 mm - Standard Gingival Profile

IP VITMA Vite di Ricambio Toronto - Toronto Spare Screw

DMX 1/2 Standard Torx Driver



Pilastro Temporaneo Toronto - Titanio Gr. 5

Toronto Temporary Abutment - Titanium Gr. 5

EP MT Rotating - Bonding Technique - Incollaggio Passivo

EP MTS Rotating - Welding Technique - Saldatura Intraorale

EP MV Vite di Ricambio Toronto - Toronto Spare Screw

DMX 1/2 Standard Torx Driver



Pilastrini di Guarigione e Transfer Toronto

Toronto Healing Abutment and Impression Coping

EP MI Rotating - Standard Gingival Profile

EP MHA H 4 mm - Standard Gingival Profile

EP MHA6 H 6 mm - Large Gingival Profile

DMX 1/2 Standard Torx Driver



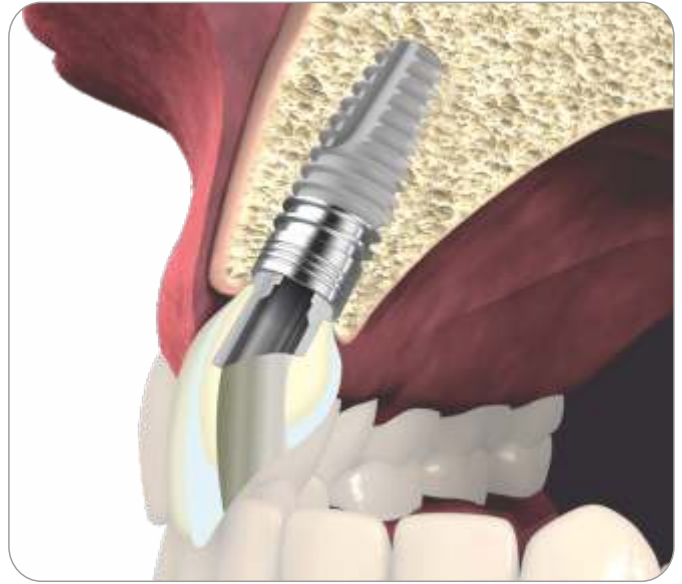
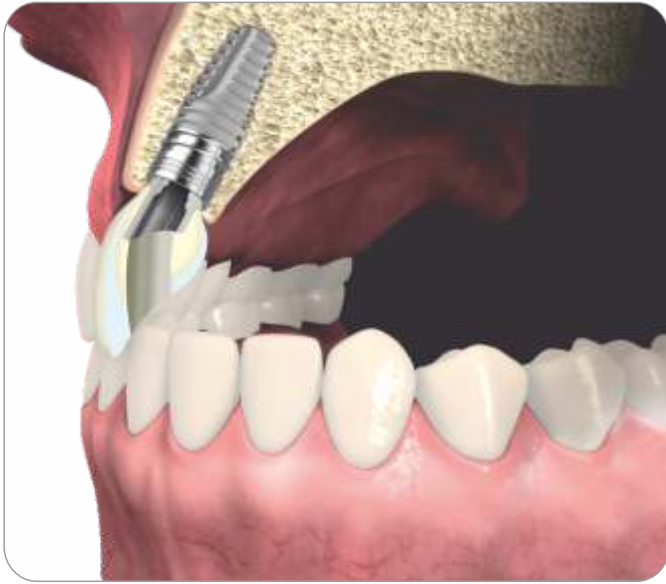

GESTIONE DEL PASSAGGIO VITE INCLINATO IN PROTESI AVVITATA

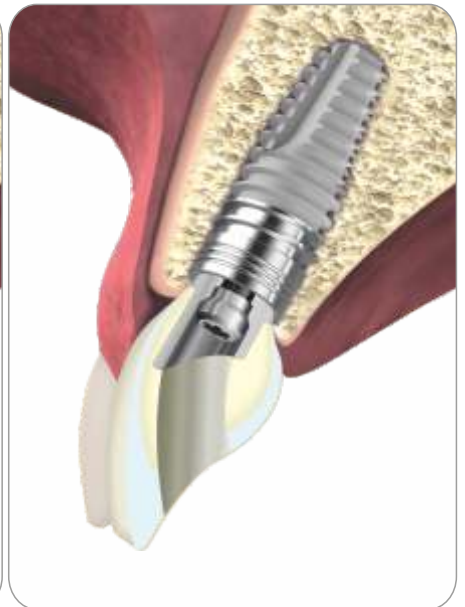
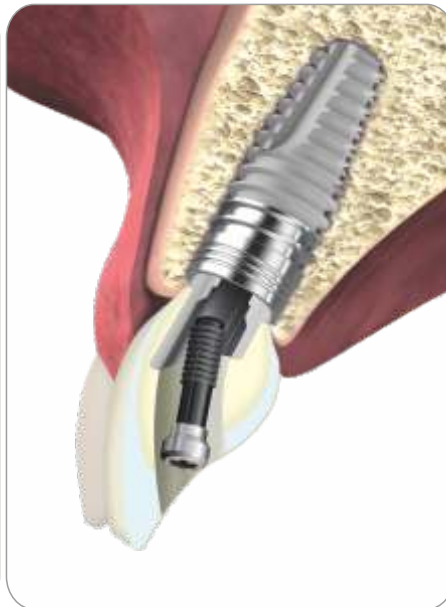
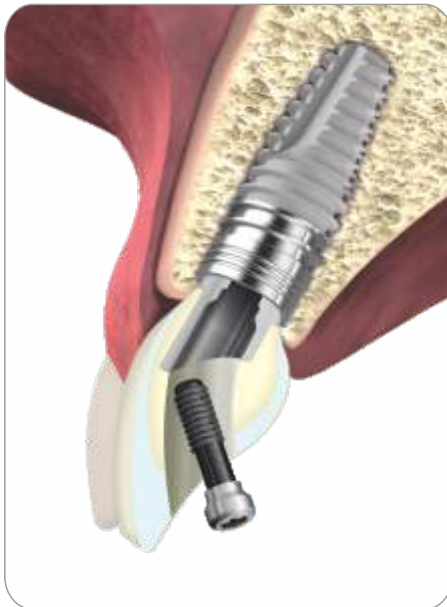

AVVITAMENTO ANGOLATO CON T6 ANGLED TORX DRIVER



SPARE SCREWS & MOUNTERS

REPLACEMENT PRODUCTS

SCREWS & MOUNTERS

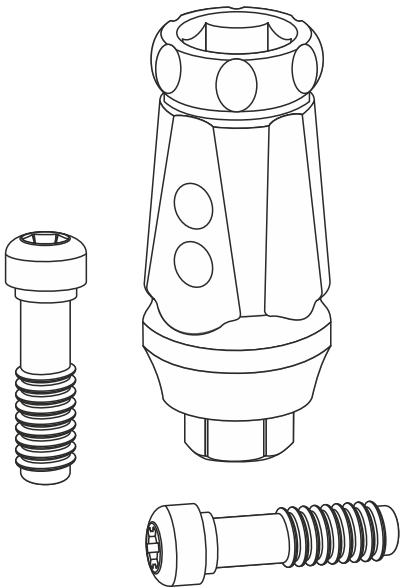



spare screws

ESAGONO INTERNO IK / IA / IC - INTERNAL HEXAGON IK / IA / IC

IP VIT20	H 20mm Transfer Screw - Ø 1.8mm	25Ncm		
IP VIT30	H 30mm Transfer Screw - Ø 1.8mm	25Ncm		
IP VIT	H 8mm Prosthetic Screw - Ø 1.8mm	32Ncm		
IP VITG	H 8mm Prosthetic Screw - Ø 1.8mm - Gold PVD TiN	32Ncm		
IP VITT6DS	Prosthetic Screw T6 per Avvitamento Angolato - Ø 1.8mm	20Ncm		
IP VITMA	Angled 17°/30° MUA Abutment Screw - Ø 1.8mm	32Ncm		

RICAMBI DI MOUNTERS IMPIANTI - IMPLANT MOUNTERS SPARE PARTS

MTA Mounter Transfer Abutment - Titanio Gr. 5				
MTA Mounter Transfer Abutment - Titanium Gr. 5				
IPM 35	H 12mm - Ø 4.5mm Internal Hexagon (IC30 - IC34)			32Ncm
IPM 40	H 12mm - Ø 4.7mm Internal Hexagon (34 - 38 - 42)			
IPM 46	H 12mm - Ø 5.5mm Internal Hexagon (46 - 50)			
DM 1/2	Standard Hexagonal Driver			

INSTRUMENTS & DRILLS

IMPLANT TOOLS

DRILLS

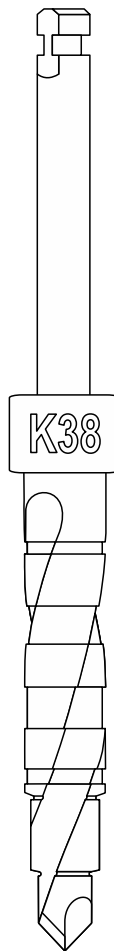

S standard surgical drills

FRESE HBM - Hard Bone Management



07001604 Cortical Drill - Ø 1.6 mm - 11 mm



04002104 Cortical Drill - Ø 2.1 mm - 11 mm



FLS2313 Lance Drill - Ø 2.3 mm - 13 mm

FIS- CORTICALS



FIS 30 Cortical Drill - Ø 3.0 mm



FIS 35 Cortical Drill - Ø 3.5 mm



FIS 40 Cortical Drill - Ø 4.0 mm



FIS 50 Cortical Drill - Ø 5.0 mm

FCS - CYLINDRICALS



FCS 20 Cylindrical Drill - Ø 2.0 mm - Long 18 mm



FCS 30 Cylindrical Drill - Ø 2.6 mm - Long 18 mm



FCS 34 Cylindrical Drill - Ø 2.9 mm - Long 18 mm



FCS 38 Cylindrical Drill - Ø 3.2 mm - Long 18 mm



FCS 42 Cylindrical Drill - Ø 3.6 mm - Long 18 mm



FCS 46 Cylindrical Drill - Ø 3.9 mm - Long 18 mm



FCS 50 Cylindrical Drill - Ø 4.4 mm - Long 18 mm



FCS 55 Cylindrical Drill - Ø 4.7 mm - Long 18 mm

S standard surgical drills

FKS - TAPERED

FKS 30 Tapered Drill - Ø 2.4 mm - Long 18 mm



FKS 34 Tapered Drill - Ø 2.9 mm - Long 18 mm



FKS 38 Tapered Drill - Ø 3.25 mm - Long 18 mm



FKS 42 Tapered Drill - Ø 3.5 mm - Long 18 mm



FKS 46 Tapered Drill - Ø 3.85 mm - Long 18 mm



FKS 50 Tapered Drill - Ø 4.35 mm - Long 18 mm



FKS - EXTRALARGE

FKS 60 Tapered Drill - Ø 5.0 mm - 15 mm



FKS 80 Tapered Drill - Ø 7.0 mm - 15 mm



MUCOTOMI - TISSUE PUNCHES

ST M13 Manual Tissue Punche - Ø3.0mm

ST M14 Manual Tissue Punche - Ø4.1mm

ST M15 Manual Tissue Punche - Ø5.1mm

ST M23 Contrangle Tissue Punche - Ø3.0mm

ST M24 Contrangle Tissue Punche - Ø4.1mm

ST M25 Contrangle Tissue Punche - Ø5.1mm



calibrated surgical drills

FCC 20 - CYLINDRICALS



FCC 2007 Cylindrical Drill - Ø 2.0 mm - Long 7 mm

FCC 2008 Cylindrical Drill - Ø 2.0 mm - Long 8,5 mm

FCC 2010 Cylindrical Drill - Ø 2.0 mm - Long 10 mm

FCC 2011 Cylindrical Drill - Ø 2.0 mm - Long 11,5 mm

FCC 2013 Cylindrical Drill - Ø 2.0 mm - Long 13 mm

FKC 34 - TAPERED



FKC 3407 Tapered Drill - Ø 2.9 mm - Long 7 mm

FKC 3408 Tapered Drill - Ø 2.9 mm - Long 8,5 mm

FKC 3410 Tapered Drill - Ø 2.9 mm - Long 10 mm

FKC 3411 Tapered Drill - Ø 2.9 mm - Long 11,5 mm

FKC 3413 Tapered Drill - Ø 2.9 mm - Long 13 mm

FKC 38 - TAPERED



FKC 3807 Tapered Drill - Ø 3.2 mm - Long 7 mm

FKC 3808 Tapered Drill - Ø 3.2 mm - Long 8,5 mm

FKC 3810 Tapered Drill - Ø 3.2 mm - Long 10 mm

FKC 3811 Tapered Drill - Ø 3.2 mm - Long 11,5 mm

FKC 3813 Tapered Drill - Ø 3.2 mm - Long 13 mm

calibrated surgical drills

FKC 42 - TAPERED

FKC 4207 Tapered Drill - Ø 3.5 mm - Long 7 mm



FKC 4208 Tapered Drill - Ø 3.5 mm - Long 8,5 mm



FKC 4210 Tapered Drill - Ø 3.5 mm - Long 10 mm



FKC 4211 Tapered Drill - Ø 3.5 mm - Long 11,5 mm



FKC 4213 Tapered Drill - Ø 3.5 mm - Long 13 mm



FKC 46 - TAPERED

FKC 4607 Tapered Drill - Ø 3.9 mm - Long 7 mm



FKC 4608 Tapered Drill - Ø 3.9 mm - Long 8,5 mm



FKC 4610 Tapered Drill - Ø 3.9 mm - Long 10 mm



FKC 4611 Tapered Drill - Ø 3.9 mm - Long 11,5 mm



FKC 4613 Tapered Drill - Ø 3.9 mm - Long 13 mm



FKC 50 - TAPERED

FKC 5007 Tapered Drill - Ø 4.3 mm - Long 7 mm



FKC 5008 Tapered Drill - Ø 4.3 mm - Long 8,5 mm



FKC 5010 Tapered Drill - Ø 4.3 mm - Long 10 mm



FKC 5011 Tapered Drill - Ø 4.3 mm - Long 11,5 mm



FKC 5013 Tapered Drill - Ø 4.3 mm - Long 13 mm



universal surgical drills

FC - CYLINDRICALS



FC 2013B Cylindrical Drill - Ø 2.0 mm - 13 mm

FC 2018B Cylindrical Drill - Ø 2.0 mm - 18 mm



FC 2613B Cylindrical Drill - Ø 2.6 mm - 13 mm

FC 2618B Cylindrical Drill - Ø 2.6 mm - 18 mm



FC 3013B Cylindrical Drill - Ø 3.0 mm - 13 mm

FC 3018B Cylindrical Drill - Ø 3.0 mm - 18 mm



FC 3213B Cylindrical Drill - Ø 3.2 mm - 13 mm

FC 3218B Cylindrical Drill - Ø 3.2 mm - 18 mm



FC 3413B Cylindrical Drill - Ø 3.4 mm - 13 mm

FC 3418B Cylindrical Drill - Ø 3.4 mm - 18 mm



FC 3813B Cylindrical Drill - Ø 3.8 mm - 13 mm

FC 3818B Cylindrical Drill - Ø 3.8 mm - 18 mm



FC 4213B Cylindrical Drill - Ø 4.2 mm - 13 mm

FC 4218B Cylindrical Drill - Ø 4.2 mm - 18 mm

F - SPECIAL DRILLS



FLS2313 Lance Drill - Ø 2.3 mm - L13 mm

FLS2318 Lance Drill - Ø 2.3 mm - L18 mm



FBP Bone Profiler - Ø 5.0 mm - Int/Ext Hex
(Velocità Max di rotazione antioraria 80 rpm)



FT 3038 Trephine - Ø 3.0 mm / Ø 3.8 mm

FT 4048 Trephine - Ø 4.0 mm / Ø 4.8 mm

FT 5058 Trephine - Ø 5.0 mm / Ø 5.8 mm

FT 6068 Trephine - Ø 6.0 mm / Ø 6.8 mm



PF Drill Extension - Prolunga per Frese



guided surgical drills

SLEEVE



PEEK
BOC415P

SLEEVE



TITANIUM
BOC415T

SLEEVE



PIN
BOC15

SMALL DRIVER
Ø 4.15



SLEEVE



REDUCER
BOC55P

SLEEVE



PEEK
BOC55P

SLEEVE



TITANIUM
BOC55T

LARGE DRIVER
Ø 5.5

FG - SPECIAL DRILLS

FGR P15

Pins Drill - Ø 1.5 mm

FGR B55 L

Bone Mill Drill - Ø 5.5 mm - ● Large

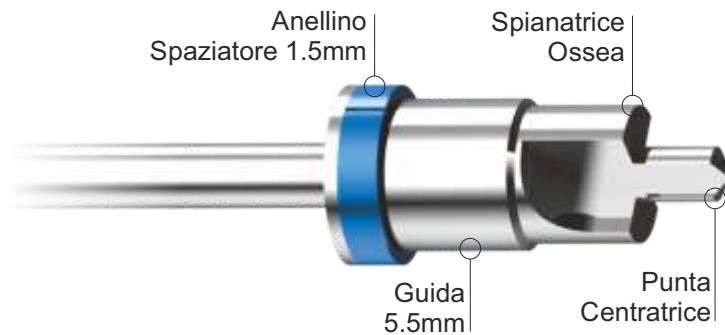

FG M - MUCOTOMES

FGR M41 S

Mucotome Drill - Ø 4.1 mm - ● Small

FGR M45 L

Mucotome Drill - Ø 4.5 mm - ● Large

FGR M55 L

Mucotome Drill - Ø 5.3 mm - ● Large

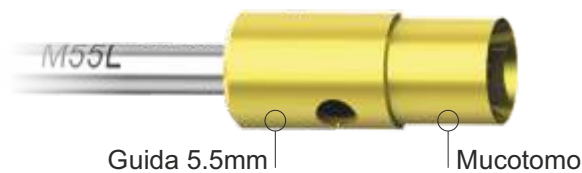

guided surgical drills



FG C - CORTICAL DRILLS



- FGR C35 S** Corticall Drill - Ø 3.5 mm - ● Small
- FGR C40 S** Corticall Drill - Ø 4.0 mm - ● Small
- FGR C35 L** Corticall Drill - Ø 3.5 mm - ● Large
- FGR C40 L** Corticall Drill - Ø 4.0 mm - ● Large
- FGR C50 L** Corticall Drill - Ø 5.0 mm - ● Large

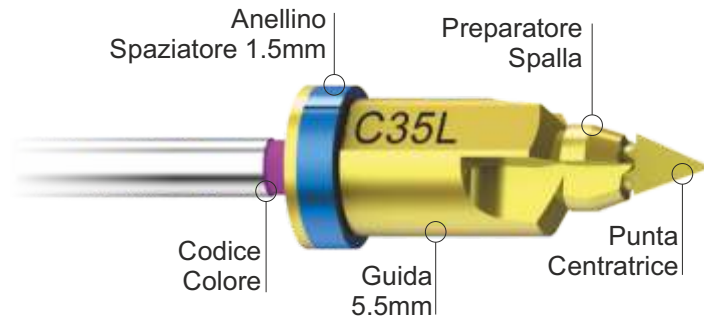

FG 20 S - FIRST DRILLS ● Small Driver



- FGR 2008 S** First Drill - Ø 2.0 mm - Long 8,5 mm
- FGR 2010 S** First Drill - Ø 2.0 mm - Long 10 mm
- FGR 2011 S** First Drill - Ø 2.0 mm - Long 11,5 mm
- FGR 2013 S** First Drill - Ø 2.0 mm - Long 13 mm
- FGR 2015 S** First Drill - Ø 2.0 mm - Long 15 mm

FG 20 L - FIRST DRILLS ● Large Driver



- FG 2008 L** First Drill - Ø 2.0 mm - Long 8,5 mm
- FGR 2010 L** First Drill - Ø 2.0 mm - Long 10 mm
- FGR 2011 L** First Drill - Ø 2.0 mm - Long 11,5 mm
- FGR 2013 L** First Drill - Ø 2.0 mm - Long 13 mm
- FGR 2015 L** First Drill - Ø 2.0 mm - Long 15 mm



guided surgical drills

FG 34 L - 3.4 IMPLANT DRILLS ● Small Driver

- FGR 3408 S** 3.4 Implant Drill - Ø 2.9 mm - Long 8,5 mm
- FGR 3410 S** 3.4 Implant Drill - Ø 2.9 mm - Long 10 mm
- FGR 3411 S** 3.4 Implant Drill - Ø 2.9 mm - Long 11,5 mm
- FGR 3413 S** 3.4 Implant Drill - Ø 2.9 mm - Long 13 mm
- FGR 3415 S** 3.4 Implant Drill - Ø 2.9 mm - Long 15 mm



FG 34 L - 3.4 IMPLANT DRILLS ● Large Driver

- FGR 3408 L** 3.4 Implant Drill - Ø 2.9 mm - Long 8,5 mm
- FGR 3410 L** 3.4 Implant Drill - Ø 2.9 mm - Long 10 mm
- FGR 3411 L** 3.4 Implant Drill - Ø 2.9 mm - Long 11,5 mm
- FGR 3413 L** 3.4 Implant Drill - Ø 2.9 mm - Long 13 mm
- FGR 3415 L** 3.4 Implant Drill - Ø 2.9 mm - Long 15 mm



FG 38 S - 3.8 IMPLANT DRILLS ● Small Driver

- FGR 3808 S** 3.8 Implant Drill - Ø 3.3 mm - Long 8,5 mm
- FGR 3810 S** 3.8 Implant Drill - Ø 3.3 mm - Long 10 mm
- FGR 3811 S** 3.8 Implant Drill - Ø 3.3 mm - Long 11,5 mm
- FGR 3813 S** 3.8 Implant Drill - Ø 3.3 mm - Long 13 mm
- FGR 3815 S** 3.8 Implant Drill - Ø 3.3 mm - Long 15 mm



FG 38 L - 3.8 IMPLANT DRILLS ● Large Driver

- FGR 3808 L** 3.8 Implant Drill - Ø 3.3 mm - Long 8,5 mm
- FGR 3810 L** 3.8 Implant Drill - Ø 3.3 mm - Long 10 mm
- FGR 3811 L** 3.8 Implant Drill - Ø 3.3 mm - Long 11,5 mm
- FGR 3813 L** 3.8 Implant Drill - Ø 3.3 mm - Long 13 mm
- FGR 3815 L** 3.8 Implant Drill - Ø 3.3 mm - Long 15 mm



guided surgical drills



FG 42 S - 4.2 IMPLANT DRILLS ● Small Driver



- FGR 4208 S** 4.2 Implant Drill - Ø 3.6 mm - Long 8,5 mm
- FGR 4210 S** 4.2 Implant Drill - Ø 3.6 mm - Long 10 mm
- FGR 4211 S** 4.2 Implant Drill - Ø 3.6 mm - Long 11,5 mm
- FGR 4213 S** 4.2 Implant Drill - Ø 3.6 mm - Long 13 mm
- FGR 4215 S** 4.2 Implant Drill - Ø 3.6 mm - Long 15 mm

FG 42 L - 4.2 IMPLANT DRILLS ● Large Driver



- FGR 4208 L** 4.2 Implant Drill - Ø 3.6 mm - Long 8,5 mm
- FGR 4210 L** 4.2 Implant Drill - Ø 3.6 mm - Long 10 mm
- FGR 4211 L** 4.2 Implant Drill - Ø 3.6 mm - Long 11,5 mm
- FGR 4213 L** 4.2 Implant Drill - Ø 3.6 mm - Long 13 mm
- FGR 4215 L** 4.2 Implant Drill - Ø 3.6 mm - Long 15 mm

FG 46 L - 4.6 IMPLANT DRILLS ● Large Driver



- FGR 4608 L** 4.6 Implant Drill - Ø 3.9 mm - Long 8,5 mm
- FGR 4610 L** 4.6 Implant Drill - Ø 3.9 mm - Long 10 mm
- FGR 4611 L** 4.6 Implant Drill - Ø 3.9 mm - Long 11,5 mm
- FGR 4613 L** 4.6 Implant Drill - Ø 3.9 mm - Long 13 mm
- FGR 4615 L** 4.6 Implant Drill - Ø 3.9 mm - Long 15 mm

FG 50 L - 5.0 IMPLANT DRILLS ● Large Driver



- FGR 5008 L** 5.0 Implant Drill - Ø 4.3 mm - Long 8,5 mm
- FGR 5010 L** 5.0 Implant Drill - Ø 4.3 mm - Long 10 mm
- FGR 5011 L** 5.0 Implant Drill - Ø 4.3 mm - Long 11,5 mm
- FGR 5013 L** 5.0 Implant Drill - Ø 4.3 mm - Long 13 mm



guided surgical drills

GUIDED MOUNTERS

- IP4MG 4S** Mounter Guidata - Internal Hex ● Small Drive
- IP4MG 4L** Mounter Guidata - Internal Hex ● Large Drive

- SP3MG 3S** Mounter Guidata - External Hex ● Small Drive
- SP4MG 4S** Mounter Guidata - External Hex ● Small Drive
- SP4MG 4L** Mounter Guidata - External Hex ● Large Drive

- IP3MG 3S-P** Mounter Guidata - Platinum CC ● Small Drive
- IP3MG 3L-P** Mounter Guidata - Platinum CC ● Large Drive
- IP4MG 4L-P** Mounter Guidata - Platinum CC ● Large Drive

Small Drive



Large Drive



Large Drive



Allineatori di Fase Esagonale
Hexagonal Phase Aligners



Large Peek Sleeve



Small Peek Sleeve



Large Titanium Sleeve



Small Titanium Sleeve



surgical kits



surgical kits

KIT 001MC	Kit Chirurgico Monolinea Cilindriche - BOX02 + Frese + Accessori
KIT 001MK	Kit Chirurgico Monolinea Coniche - BOX02 + Frese + Accessori
KIT 001PC	Kit Chirurgico Monolinea Platinum Cilindriche - BOX02 + Frese + Accessori
KIT 001PK	Kit Chirurgico Monolinea Platinum Coniche - BOX02 + Frese + Accessori
KIT 002	Kit Chirurgico Standard - BOX + Frese + Accessori
KIT 002P	Kit Chirurgico Platinum Standard - BOX + Frese + Accessori
KIT 004	Kit Chirurgico Mini Implant - BOX 03 + CRND + Frese + Accessori
KIT FCK	Kit Chirurgico Calibrate K - BOX FCK + Frese + Accessori
KIT 009	Kit Chirurgico UNI-Q-MUA 2.0 - BOX 02 + Frese + Accessori
KIT RPS01	Kit Protesico REPLICA - BOX RP01 + 5 Drivers Corti
KIT RPS02	Kit Protesico REPLICA - BOX RP01 + 5 Drivers Corti + Cricchetto Dinamom.
KIT RPL01	Kit Protesico REPLICA - BOX RP01 + 5 Drivers Lunghi
KIT RPL02	Kit Protesico REPLICA - BOX RP01 + 5 Drivers Lunghi + Cricchetto Dinamom.
BOX	Box Chirurgico Implantologia Large - Solo contenitore
BOX 02	Box Chirurgico Implantologia Monolinea Medium - Solo contenitore
BOX RP01	Box Protesico REPLICA - Solo contenitore



KIT 001
Monolinea



Kit Protesico
REPLICA



surgical kits

KIT 005	Kit Chirurgico Espansori - BOX 03 + 4 Espansori + Accessori
KIT 006	Kit Chirurgico Espansori Base - BOX 03 + 4 Espansori
KIT PINK	Kit Misuratori di Parallelismo - BOX P + 10 PIN
KIT 007	Kit Rimozione Impianti EXT - BOX 03 + 2 Estrattori + Accessori
KIT RI	Kit Rimozione Impianti REPLICA - BOX + 3 Estrattori + 4 Viti + Accessori
KIT RV	Kit Rimozione Viti Fratturate REPLICA - BOX + 2 Frese + Guida + Accessori
KIT 012	Kit REVO Chirurgia Guidata - BOX + 59 Frese + Accessori
KIT 012L	Kit REVO Chirurgia Guidata solo Frese Larghe - BOX + 36 Frese + Accessori
BOX GR	Box REVOLUTION Chirurgia Guidata - Solo contenitore
KIT KN	Kit K Narrow - Box + Frese + Accessori
BPIF	Base Svita Impianti - Base in Titanio per la Rimozione del Mount
KBS	Kit Boccole Spaziatrici - 8 Boccole 2 colori per tipo + Box Inox
RBS	Ricambi Boccole Spaziatrici - 8 Boccole 2 colori per tipo



KBS Kit Boccole Spaziatrici REVO



BPIF Base Svita Impianti

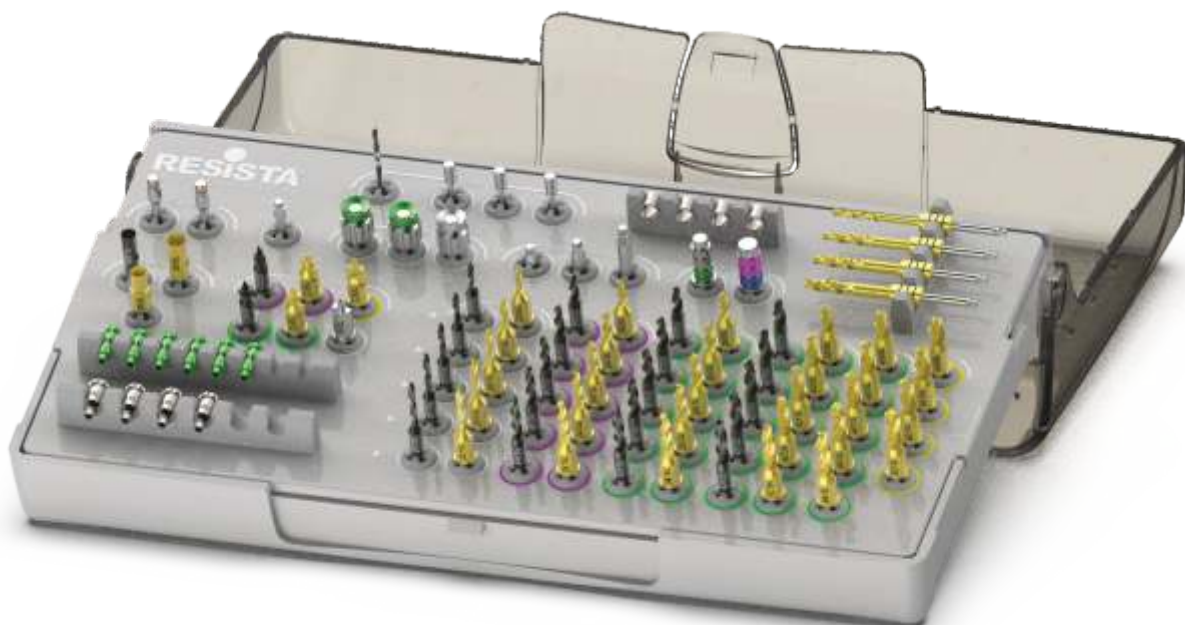

Guided Surgery REVO (Full Optional su Richiesta)

computer guided surgery



computer guided surgery

MASCHERINA CHIRURGICA - Mascherina on demand multi-impianti

SURGICAL GUIDE - Multi-implants on demand surgical guide

DS PAK Progetto + Mascherina + Modello + Boccole

NB - Supporto tecnico sul posto per i primi 3 interventi
Kit Chirurgico in comodato d'uso per i primi 3 interventi

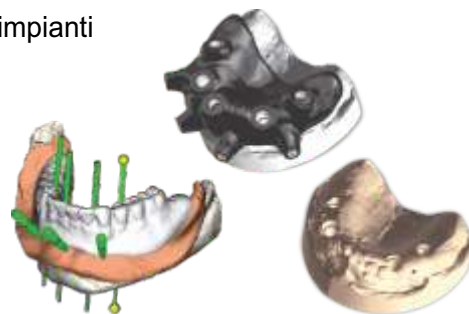

MASCHERINA CHIRURGICA - Mascherina on demand multi-impianti

SURGICAL GUIDE - Multi-implants on demand surgical guide

DS PAK-M Progetto + Mascherina + Boccole

NB - Supporto tecnico sul posto per i primi 3 interventi
Kit Chirurgico in comodato d'uso per i primi 3 interventi

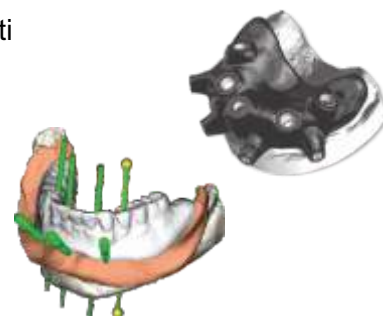

MODELLO MASTER - Modello stereolitografato, preforato per analoghi

MASTER MODEL - Pre-drilled stereolithographed model for analog

DS MOD Modello da stampa Digitale di precisione



MASCHERINA CHIRURGICA - Mascherina on demand multi-impianti

SURGICAL GUIDE - Multi-implants on demand surgical guide

DS PAK 1 Mascherina 1 Impianto + Modello + Boccole

DS PAK 4 Mascherina 4 Impianti + Modello + Boccole

DS PAK 8 Mascherina 8 Impianti + Modello + Boccole

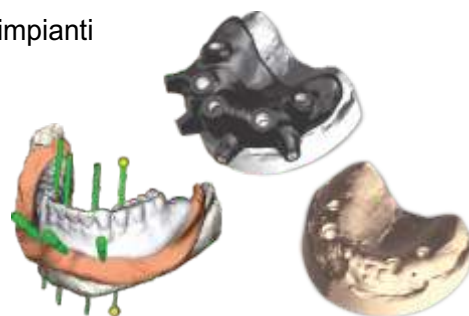

PROTESI PROVVISORIA IMMEDIATA - PMMA Stratificato Fresato + Armatura in Titanio Fresata

IMMEDIATE TEMPORARY PROSTHESIS - Drilled PMMA + Milled Titanium Framework

DS PTD Protesi Provvisoria Total Digital - PMMA + Armatura



computer guided surgery

1

MODELLO PANORAMICO - Ottenuto dalla ribasatura della protesi

Modello di precisione, integro, squadrato e rifinito

Materiale: Gesso di qualità Classe 4

Ribasare la protesi con materiale da impronta o prendere un'impronta di precisione se parzialmente edentulo



2

DUPLICATO DELLA PROTESI - Realizzato sul modello panoramico

Copia conforme della protesi mobile senza sottosquadri vestibolari

Materiale: Resina ortodontica trasparente

Il dupliato è una copia di precisione di una protesi o di una ceratura diagnostica se il paziente è parzialmente edentulo



3

MARKER RADIOLOGICI - Incollaggio delle palline di quarzo

6/8 palline, in posizioni sfalsate non lineari tra loro

Materiale: Sfere di quarzo delle sterilizzatrici a palline

Le palline vanno incollate con cianocrilato per metà del loro diametro nella resina ed il resto emergente, con posizioni sfalsate tra loro



4

TAC CONE BEAM - Rimuovere ponti e corone metalliche se possibile

Paziente con duplicato in bocca e spaziatore intraorale tra le arcate

Dati DICOM standard inviati via mail in una cartella compressa

Il metallo di ponti e corone genera grandi quantità di scattering che altera l'interpretazione dei dati DICOM e la precisione



5

STL ANATOMIA e WAXUP PROTESICO - 2/3 File STL

1 File STL Modello Gengivale/Dentale

1 File STL Modello + WaxUp Protesico (Duplicato della Protesi)

Inviare per e-mail in cartella compressa



6

CREAZIONE DEL CASO - Ambiente virtuale per progettazione chirurgica

Trasformiamo il vostro materiale in un caso unico, già caricato nel

Programma di Pianificazione e ve lo condividiamo sul vostro Software

I file STL di modello, duplicato e/o scan-marker, li sovrapponiamo alla TAC (matching) all'interno del programma, per visualizzare ossa, tessuti molli e protesi

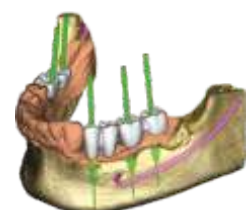

computer guided surgery

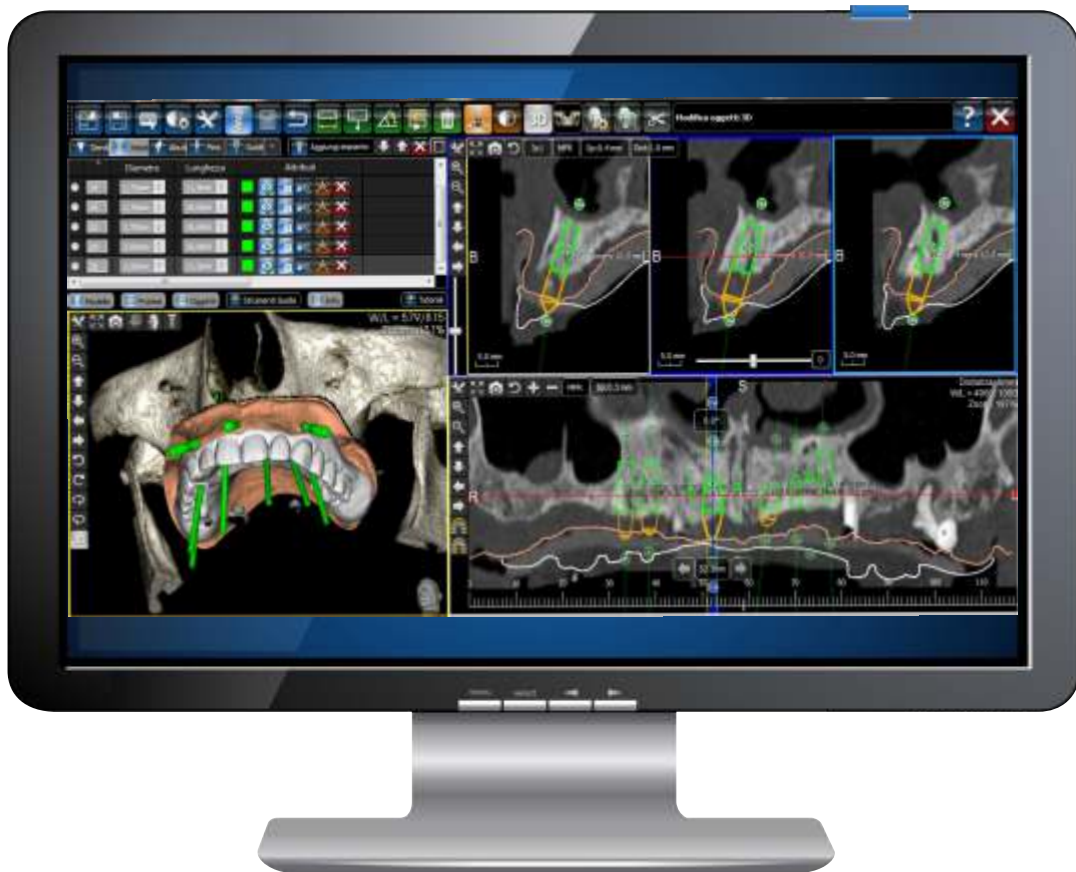

CORSI DI FORMAZIONE TEORICO/PRATICI SU PC

Il futuro è digitale e la chirurgia computer guidata cammina al fianco della rivoluzione cad-cam che sta trasformando il nostro lavoro

impararne le basi, conoscerne le potenzialità, comprenderne i limiti per evitare errori e per migliorare il nostro quotidiano

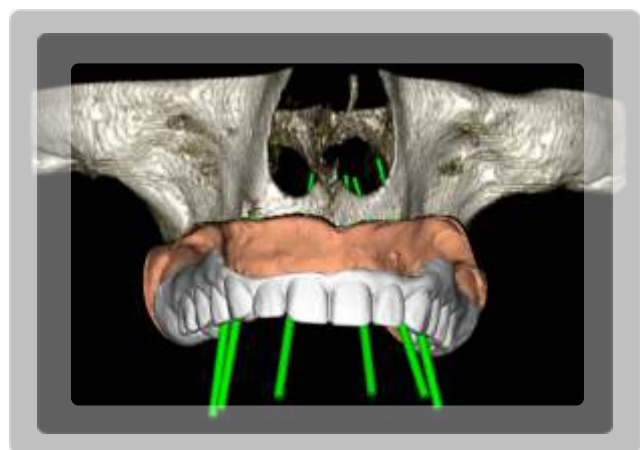
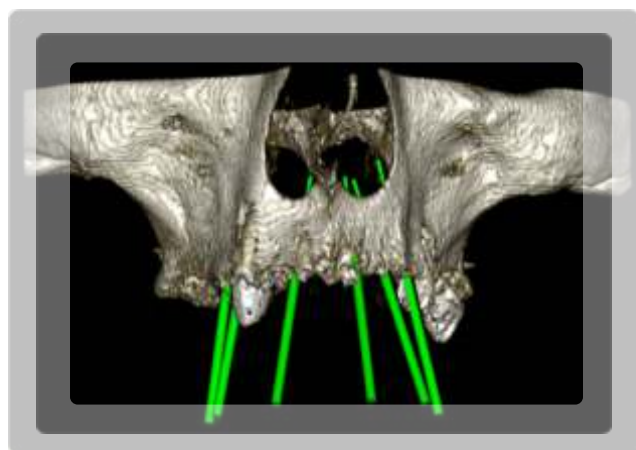

OVERDENTURE & PROSTHETICS

ATTACHMENTS



overdenture



Kit OT Equator Esagono Interno - Pilastro + Contenitore + Cappette

Kit OT Equator Internal Hexagon - Abutment + Box + Caps

IP3EQ2	Kit OT Equator h2 mm Ø3.5	●
IP3EQ3	Kit OT Equator h3 mm Ø3.5	●
IP3EQ4	Kit OT Equator h4 mm Ø3.5	●
IP3EQ5	Kit OT Equator h5 mm Ø3.5	●
IP3EQ6	Kit OT Equator h6 mm Ø3.5	●
IP4EQ1	Kit OT Equator h1 mm Ø4.0 CPS	●
IP4EQ2	Kit OT Equator h2 mm Ø4.0 CPS	●
IP4EQ3	Kit OT Equator h3 mm Ø4.0 CPS	●
IP4EQ4	Kit OT Equator h4 mm Ø4.0 CPS	●
IP4EQ5	Kit OT Equator h5 mm Ø4.0 CPS	●
IP4EQ6	Kit OT Equator h6 mm Ø4.0 CPS	●

RHEIN83



Femmine per Overdenture Equator - Ritenzioni Rhein

Equator Overdenture Caps - Rhein Caps

TF Q1	Teflon Viola Forte
TF Q2	Teflon Bianco Normale
TF Q3	Teflon Rosa Morbida
TF Q4	Teflon Giallo Extra
TF Q5	Teflon Nero da Laboratorio
SBOX EQ	Smart Box - Autoparallelizzante Cont. + 5 Teflon
COQ 01	Metal Box - Stainless Steel
COQ 02	Metal Box - Titanium

RHEIN83

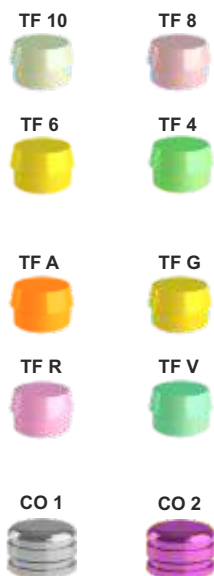

Femmine per Overdenture Normo - Ritenzioni Rhein

Normo Overdenture Caps - Rhein Caps

TF 10	Teflon Bianca 1300 gr.
TF 08	Teflon Rosa 800 gr.
TF 06	Teflon Gialla 600 gr.
TF 04	Teflon Verde 400 gr.
TF A	Sottodimensionata - Teflon Arancione 350 gr.
TF G	Sottodimensionata - Teflon Gialla 500 gr.
TF R	Sottodimensionata - Teflon Rosa 900 gr.
TF V	Sottodimensionata - Teflon Verde 1300 gr.
CO 01	Metal Box - Stainless Steel
CO 02	Metal Box - Titanium

RHEIN83

overdenture

Femmine per Overdenture Micro - Ritenzioni Rhein

Micro Overdenture Caps - Rhein Caps

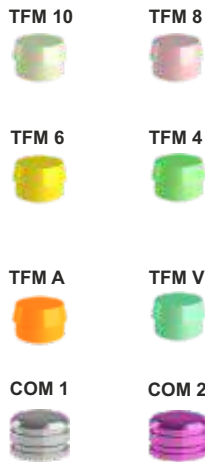

TFM 10	Teflon Bianca 1100 gr.
TFM 08	Teflon Rosa 800 gr.
TFM 06	Teflon Gialla 450 gr.
TFM 04	Teflon Verde 200 gr.
TFM A	Sottodimensionata - Teflon Arancione 200 gr.
TFM V	Sottodimensionata - Teflon Verde 1100 gr.
COM 01	Metal Box - Stainless Steel
COM 02	Metal Box - Titanium

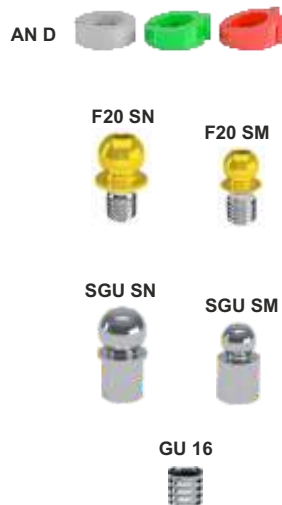

AN D	Anelli Direzionali 0° - 7° - 14° - Conf 6pz.
F20 SN	Sfera Normo Filettata - Passo Filetto M2.0
F16 SN	Sfera Normo Filettata - Passo Filetto M1.6
F20 SM	Sfera Micro Filettata - Passo Filetto M2.0
F16 SM	Sfera Micro Filettata - Passo Filetto M1.6
SGU SN	Spaziatore Sfera Normo per Guaina Filettata
SGU SM	Spaziatore Sfera Micro per Guaina Filettata
GU 16	Guaina Filettata da Incollaggio - Passo Filetto M1.6



SC N	Sfera Calcinabile Normo Verde - 4pz.
SC M	Sfera Calcinabile Micro Rossa - 4pz.
DPI	Dischetto Protettivo per Incollaggio Trasparente - 10pz.
SC 25	Sfera Cava da Incollaggio Normo - Per sfere usurate - 2pz.
SC 18	Sfera Cava da Incollaggio Micro - Per sfere usurate - 2pz.
BA 01	Barra tipo Dolder Calcinabile
BA 02	Ritenzione in Teflon Rosa per Barra
BA 03	Ritenzione in Teflon Gialla per Barra

overdenture

- BCA N** Barra Calcinabile Angolare **Normo** Verde - 2pz.
BCD N Barra Calcinabile Diritta **Normo** Verde - 2pz.
BCA M Barra Calcinabile Angolare **Micro** Rossa - 2pz.
BCD M Barra Calcinabile Diritta **Micro** Rossa - 2pz.
- F20 EQ** Equator Filettato - Passo Filetto M2.0
F16 EQ Equator Filettato - Passo Filetto M1.6
- SGU EQ** Equator Spaziatore per Guaina Filettata
AL EQ Analogo per Laboratorio Equator



RHEIN83

Kit LOCATOR® Esagono Interno - Pilastro + Contenitore + Caps

Kit LOCATOR® Internal Hexagon - Abutment + Box + Caps

- IP4LC1** Kit LOCATOR h1 mm - Ø4.0 CPS ●
IP4LC2 Kit LOCATOR h2 mm - Ø4.0 CPS ●
IP4LC3 Kit LOCATOR h3 mm - Ø4.0 CPS ●
IP4LC4 Kit LOCATOR h4 mm - Ø4.0 CPS ●
IP4LC5 Kit LOCATOR h5 mm - Ø4.0 CPS ●
IP4LC6 Kit LOCATOR h6 mm - Ø4.0 CPS ●



- TSLC** Transfer Ti + Cappetta Nera (per laboratorio)
COLC1 Contenitore Ti + Cappetta Nera (per laboratorio)
NBOXLC Kit Cappette + Contenitore Ti
TFLC50 Cappetta Ritentiva Trasparente - 2268 g 4 pz.
TFLC30 Cappetta Ritentiva Rosa - 1361 g 4 pz.
TFLC15 Cappetta Ritentiva Blu - 680 g 4 pz.
ALLC Analogo in Titanio
TFLCD40 Cappetta Ritentiva Verde - 1814 g 4 pz.
TFLCD20 Cappetta ritentiva Arancione - 907 g 4 pz.
TFLCD15 Cappetta ritentiva Rossa - 680 g 4 pz.
DMLC Avvitatore manuale da Cricchetto
DCLC Avvitatore da Contrangolo
IELC Inseritore / Estrattore Cappette



LOCATOR®

INSTRUMENTS & TOOLS

IMPLANT TOOLS

DRIVERS

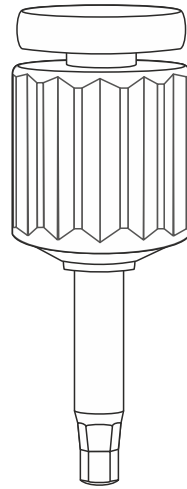

instruments and tools

CACCIAVITI MANUALI - MANUAL SCREW DRIVERS



DM 01 **Hexagonal 1.27** - Short - 12mm



DM 02 **Hexagonal 1.27** - Medium - 17mm

DM 03 **Hexagonal 1.27** - Long - 27mm



DMX 01 **Torx** - Short - 15mm

DMX 02 **Torx** - Long - 20mm



DMRP120S **Hexagonal 1.20** - Short

DMRP120L **Hexagonal 1.20** - Long



DM T6DS **T6 Angled Torx Driver** - 15mm

DMEQ **Equator Squared** - Short - 15mm

CACCIAVITI DA CONTRANGOLO - CONTRA-ANGLE SCREW DRIVERS



DC 01 **Hexagonal 1.27** - Short - 15mm



DC 02 **Hexagonal 1.27** - Medium - 20mm



DC 03 **Hexagonal 1.27** - Long - 30mm



ACDRCA **Hexagonal 1.20**

DC T6DS **T6 Angled Torx Driver** - 20mm



DCEQ **Equator Squared** - Medium - 20mm

DCX 01 **Torx** - Short - 15mm

DCX 02 **Torx** - Long - 20mm

instruments and tools



Accessori per Applicazione Manuale

Accessories for Manual Application

CD LAB Chiave Digitale da Laboratorio Es. 3,5

ALI Aiuto da Laboratorio Esagono Interno

ALE Aiuto da Laboratorio Esagono Esterno

**UNADCR
CAES35**



Adattatore da Es. 3,5 a RA

ALI



ALE



Supporto da Laboratorio per la lavorazione dei Monconi

0°

17°

32°



Perni di Parallelismo - Titanio Gr. 5

Paralleling Pins - Titanium Gr. 5

PIN Double diameter - S 1.8mm / L 3mm - 0°

PIN17 Double diameter - S 1.8mm / L 3mm - 17°

PIN32 Double diameter - S 1.8mm / L 3mm - 32°

PIN K Kit Misuratori di Parallelismo Calibrati
(10 PIN + BOX)



A 1.3
B 2.1
C 2.4



A 1.6
B 2.8
C 3.1



A 1.9
B 3.5
C 3.8



A 2.4
B 4.3
C 4.6

Osseo Espansori e Compattatori - Titanio Gr. 5

Bone Expanders and Compactors - Titanium Gr. 5

EXP 4 Progressive diameters

KIT 005 Expander Surgical Kit

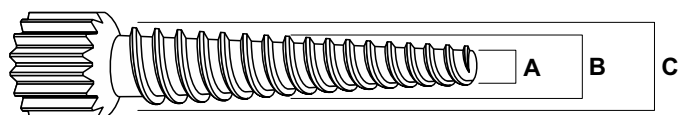

instruments and tools

CACCIAVITI DA CRICCHETTO - TORQUE CONTROLLER DRIVERS

- DCD 01** Hexagonal 1.27 - Short - 15mm
- DCD 02** Hexagonal 1.27 - Medium - 20mm
- DCD 03** Hexagonal 1.27 - Long - 30mm
- DCDX 01** Torx - Short - 15mm
- DCDX 02** Torx - Long - 20mm
- DCDM** Hexagonal - Monconi Toronto Diritti

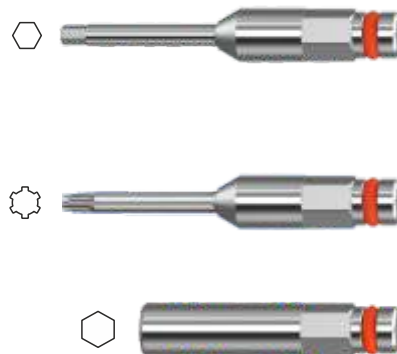

AVVITATORI MANUALI - FINGER MANUAL DEVICE

- DGM** Digitale Manuale - Manual Implant Driver
- DKX** Avvitatore Manuale per RA - RA Manual Driver
- UNADCRCAES35** Adattatore CRD2 da Es. 3,5 a RA
CRD2 Adapter from Hex 3,5 to RA

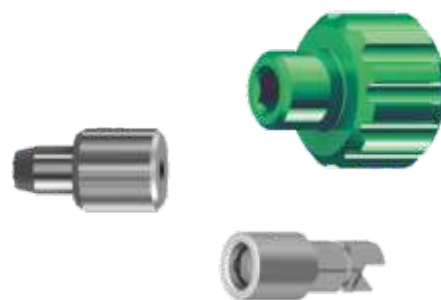

NB Controllare compatibilità vecchio e nuovo ed in alternativa catalogo REPLICA

PROLUNGHE DA CRICCHETTO - RATCHET IMPLANT DRIVERS

- PC 01R** Short - Hexagonal Implant Driver
- PC 02R** Medium - Hexagonal Implant Driver
- PC 03R** Long - Hexagonal Implant Driver
- PR PC** Prolunga per PC - PC Extension



I E

AVVITATORI DA CONTRANGOLO - CONTRA-ANGLE IMPLANT DRIVERS

- AC 01** Short - Hexagonal Implant Driver
- AC 02** Medium - Hexagonal Implant Driver



I E

instruments and tools

Avvitatori Manuali - Acciaio Inox

Manual Driver - Stainless Steel



CRND Cricchetto non Dinamometrico - No Torque Control Ratchet



CRD2-G



CRD2 Cricchetto Dinamometrico 10/70 Ncm - Torque Control

CRD2-G Ghiera Cricchetto CRD2 con Attacco PC - CRD2 Ratchet Wheel with PC Connection



CRDP2 Cricchetto Dinamometrico Protesico 10/70 Ncm - Torque Control



CDL Avvitatore Diritto Manuale - Long Manual Driver

Sonde e Misuratori - Acciaio Inox

Probes and Meters - Stainless Steel

ST PRO SL1 Sonda Compattatore Doppia - Sinus Lift System



SOM Sonda Chirurgica in Titanio
Titanium Surgical Probe

mini sinus lift

PRO Sinus Lift - Mini Rialzo del Seno per via Crestale

PRO Sinus Lift - Mini Sinus Lift with Crestal Approach

Frese Taglienti 120°



PRO SL Kit Kit Completo Box + Frese + Stop + Accessori

- FC 20** Fresa ● Tagliente 120° - Ø 2.0
- FC 2026** Fresa ● Tagliente 120° - Ø 2.0/2.6
- FC 2531** Fresa ● Tagliente 120° - Ø 2.5/3.1
- FC 31P** Fresa ● Atraumatica 180° - Ø 3.1
- FC 31PTX** Fresa ● Atraumatica TaglioX 180° - Ø 3.1
- FC 31R** Fresa ● Raggiata Atraumatica - Ø 3.1
- FC 3136R** Fresa ● Raggiata Atraumatica - Ø 3.1/3.6

KIT ST 6 Titanium Drill Stoppers (6.0/7.0/8.5/10/11.5/13)

STP KIT 11 Titanium Drill Stoppers (1.0/2.0/3.0/4.0/5.0/6.0/7.0/8.5/10/11.5/13)

ST Titanium Drill Stopper 1 pz. (Es. ST1, ST2, ST3)

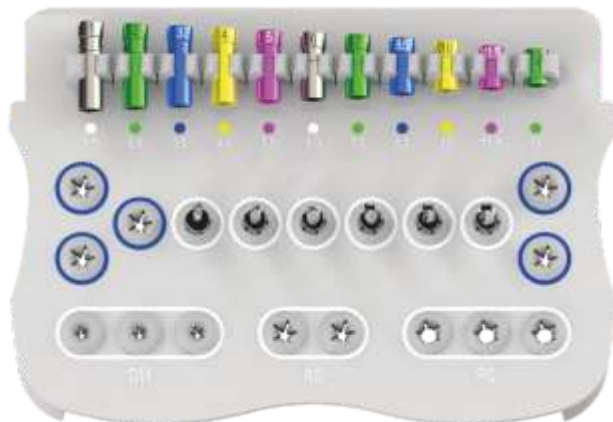

Frese Atraumatiche (Max 100 rpm)



Frese Raggiate (Max 80 rpm)



instruments and surgery

IMPIANTI FRATTURATI

UNIVERSAL IMPLANT EXTRACTOR

IMPIANTO
FRATTURATO



IMPIANTO
SOSTITUITO

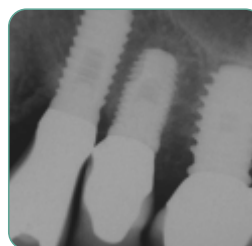

RIMOZIONE IMPIANTO IN
AVVITAMENTO ANTIORARIO



SOSTITUZIONE IMMEDIATA
CON NUOVO IMPIANTO



RIVESTIMENTO IN DLC
Durezza e Minore Attirito

FILETTO 3 PRINCIPI
120Ncm

CONICITÀ PROGRESSIVA
Incrementale

ACCIAIO EXTRADURO
68 Rockwell



EXT Implant Extractor - 1 pcs.

KIT 007 Implant Extractor Kit - 2 Extractors + 1 Box + CRND

Siringhe per Anestesia - Inox

Anesthesia Syringes - Stainless Steel



PERIPEN

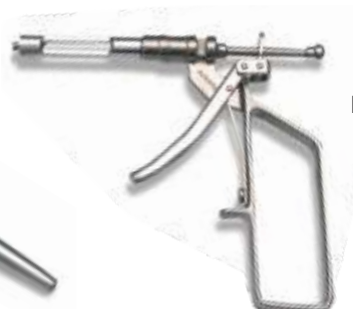

PERIPRESS



22 PERIPRESS - Siringa Inox 1.8cc - Set 2 Portafiala

32 PERIPRESS - Siringa Standard 1.8cc - Set 2 Portafiala

118 PERIPEN - Siringa Inox 1.8cc - Set 2 Portafiala AM/EU



Ing. C. A. Issoglio & C. S.r.l.
Via F.lli Di Dio, 68 - 28887 Omegna (VB) - ITALIA
Tel. +39.0323.828.004 - Fax +39.0323.828.914
www.resista.it - info@resista.it

REV 03 - 31/03/2023