

# MONOPHASIC

UNI-Q-MUA and MINI IMPLANTS

# company profile

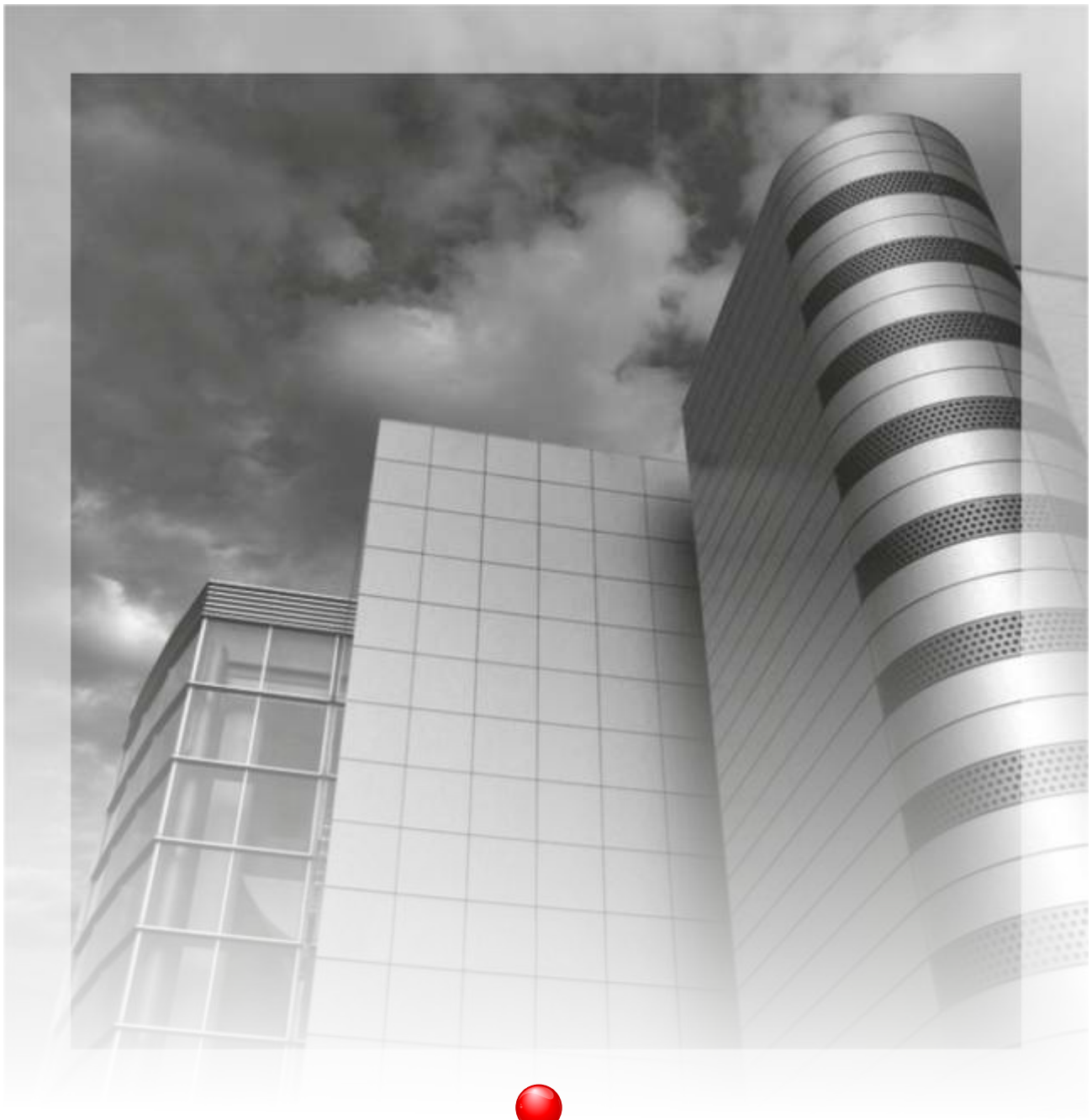

**RESISTA**<sup>®</sup>

Marchio di proprietà della **Ing. Carlo Alberto ISSOGLIO & C. S.r.l.** identifica l'intera gamma di prodotti concepiti dall'azienda per soddisfare le esigenze di odontoiatri ed odontotecnici.

since 1946

**RESISTA è sinonimo di garanzia, equilibrio e continuità, noto in tutto il mondo.**



**RESISTA**, trademark owned by Ing. Carlo Alberto Issoglio & C. S.r.l. , identifies the full range of products designed by the company to meet the needs of dentists and dental technicians.

**RESISTA is known all over the world since 1946, and synonymous of guarantee, balance and continuity.**

# company profile

L'azienda dispone di un complesso produttivo per la realizzazione di dispositivi medici, tra i più moderni del settore, situato ad Omegna, una bellissima cittadina che si affaccia sul Lago d'Orta.

Con impegno, vanto ed orgoglio, il personale tecnico e scientifico del reparto Ricerca & Sviluppo è quotidianamente dedicato a promuovere l'innovazione ed il miglioramento dei nostri prodotti e processi.



Negli anni, il marchio **RESISTA** è diventato anche sinonimo di risposta rapida e qualitativa ai cambiamenti del mercato e alle esigenze dell'odontoiatria moderna.

Qualità, Prezzo e Servizio riassumono in tre semplici parole la percezione quotidiana degli utilizzatori dei prodotti marchiati **RESISTA**.



The company has one of the most ip-to-date manufacturing site for the medical devices, located in Omegna, a beautiful town on Orta Lake, Italy.

With commitment, merit and pride, the technical and scientific staff of the R&D department is daily involved to promote innovation and the improvement of our products and processes.

Over the years, the **RESISTA** brand has also become synonymous of fast and qualitative response to market changes and the needs of modern dentistry.

Quality, Price and Service summarize in three simple words the daily perception of the users of **RESISTA** branded products.

# the choice

**RICERCA & SVILUPPO** - Il programma R&D di Resista Group nasce dalle indicazioni provenienti dal mondo clinico unite alla nostra esperienza maturata nel campo dei dispositivi medici impiantabili.

Con l'utilizzo di programmi di modellazione 3D e sofisticati sistemi computerizzati simuliamo le geometrie finali ed il design, sviluppando le fasi di prototipizzazione rapida dei progetti.



**INNOVAZIONI** - Resista Group è strutturata per soddisfare tutte le esigenze del metal-implant con una avanzata tecnologia di concezione, prototipizzazione ed ingegnerizzazione finale del prodotto per arrivare a soluzioni innovative.

La validazione viene eseguita in collaborazione con Istituti di Ricerca accreditati in conformità ai requisiti degli Standard Internazionali.



**RESEARCH & DEVELOPMENT** - The R&D Resista Group's program stems from indications from the clinical world combined with our experience in the field of implantable medical devices.

Due to the use of 3D modeling programs and sophisticated computer systems, we simulate the final geometries and the design, developing the rapid prototyping phases of the projects.

**INNOVATIONS** - Resista Group is structured to meet all the needs of the metal-implant with an advanced conception technology, prototyping and final product engineering to arrive at innovative solutions. Validation is carried out in collaboration with accredited Research Institutes following the International Standards Requirements.

# the choice

**QUALITÀ DI PROGETTO E PROCESSO** - ICIM Spa ha certificato la **Ing. C. A. Issoglio & C. S.r.l.** in accordo alle normative **UNI EN ISO 9001** e **UNI EN ISO 13485** nel rispetto di tutte le normative vigenti relative ai prodotti e servizi offerti.

Ogni dipendente che ricopre differenti ruoli (tecnici, ingegneristici, amministrativi, commerciali, operatori meccanici, ecc), segue linee guida ed obiettivi per un unico fine: il miglioramento continuo.



**OBIETTIVO PRINCIPALE** - La soddisfazione del cliente è il nostro obiettivo. Il fattore vincente è la capacità dell'azienda a risolvere nel breve qualsiasi tipo di richiesta.

Il supporto tecnico fornito dagli specialisti di prodotto, la disponibilità, l'efficienza e la cordialità sono il punto di forza della nostra struttura.



**PROJECT AND PROCESS QUALITY** - ICIM Spa certified **Ing. C. A. Issoglio & C. S.r.l.** in accordance with **UNI EN ISO 9001** and **UNI EN ISO 13485** in compliance with all current regulations relating to the products and services offered. Every employee covering different roles (technical, engineering, administrative, commercial, mechanic operators, etc.), follows guidelines and objectives for a single purpose: continuous product improvement.

**MAIN OBJECTIVE** - Customer satisfaction is our objective. The winning factor is the company's ability to quickly resolve any type of request. The technical support provided by Product Specialists, availability, efficiency and friendliness are the strengths of our structure.

# the project

**CONCETTI BIOMECCANICI** - Il successo della metodica implantare **Resista Group** è frutto di approfonditi studi sul design dei prodotti e sulla tecnologia di produzione. I risultati clinici a lungo termine sono, infatti, fortemente influenzati dalla precisione e dalla qualità.

Il **processo produttivo** viene eseguito da operatori altamente qualificati che, con l'ausilio dei sistemi elettronici CNC automatizzati, riescono ad ottenere risultati ottimali e riproducibili.



Le tolleranze di lavorazione, soprattutto negli **accoppiamenti protesici**, sono il nostro **gold standard** e vengono confinate tra i **7 - 10 µm**.

**MATERIALI** - Gli impianti sono realizzati in **Titanio ASTM Gr 4** (Norm. ISO 5832/2), le viti di ritenzione e le componenti protesiche sono realizzate in **Leghe di Titanio ASTM Gr 5** (Norm. ISO 5832/3).



**BIOMECHANICAL CONCEPTS** - The **Resista Group** method success is the result of several product design studies and the high technology applied in the production. The precision and reliability of the implant has a strong influence on the long term clinical success.

**The manufacturing process** is carried out by high qualified operators, skilled enough to obtain optimal and reproducible results with the use of electronically controlled CNC machinery. The machinery tolerances, especially in **prosthetic connections**, are our **gold standard** and are between **7 - 10 µm**.

**MATERIALS** - The implants are made of Titanium ASTM Gr. 4 (ISO Standard 5832/2) and the screws and prosthetic components are made of Titanium ASTM Gr. 5 (ISO Standard 5832/3).

# the project

**TRATTAMENTI DI SUPERFICIE** - Il processo di micro-sottrazione non contaminata, doppia acidificazione **DAE** (Double Acid Etching), modifica la micro rugosità degli impianti (**Ra, Rq**) texturizzando la superficie e massimizzando la bagnabilità ed il biomimetismo.

Il trattamento di superficie ed il processo di decontaminazione, brevettati da **Nobil Bio Ricerche**, sono in grado di migliorare le proprietà bio-chimiche degli impianti dentali **Resista**.

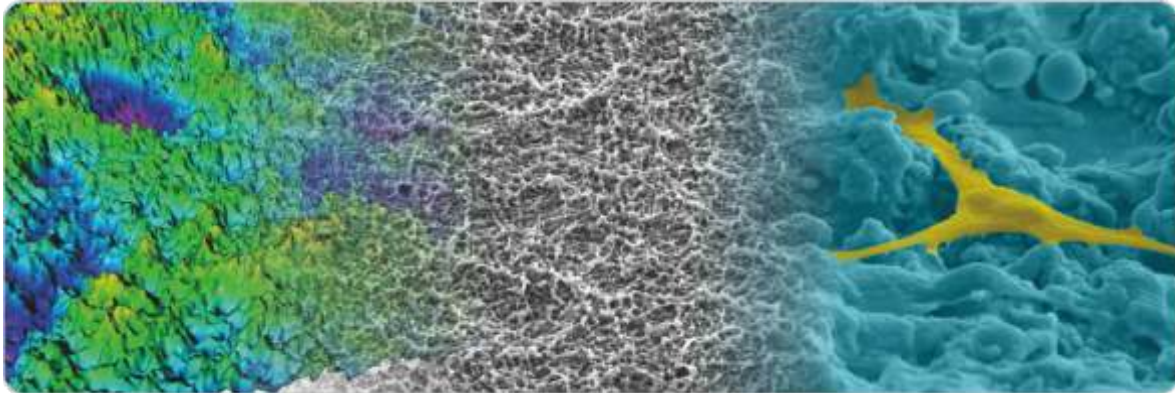

**SISTEMA QUALITÀ** - L'azienda è certificata in accordo alle norme **UNI EN ISO 9001** e **UNI EN ISO 13485** e ha ottenuto la marcatura **CE** sui propri dispositivi medici in accordo alla Direttiva Europea 93/42/CEE e ss.mm.ii. nel rispetto delle armonizzate di riferimento.

L'impegno è costante nel mantenimento della conformità.



**SURFACE TREATMENTS** - The non-contaminant micro-subtraction process, **DAE** (Double Acid Etching), changes the implant micro roughness (**Ra, Rq**) and the surface texture maximizing the wettability and biomimetic properties. The new surface treatment and decontamination process are patented by **Nobil Bio Ricerche** improving the bio-chemical properties of the implants.

**QUALITY SYSTEM (QS)** - **UNI EN ISO 9001** and **UNI EN ISO 13485** in compliance of Medical Devices Directives. We are qualified in the design and in the production management of dental implants, dental prothesis, intraligamental anesthesia syringes and abrasive discs.

# mounter - transfer - abutment - GCS

**MOUNTER PREASSEMBLATO IN TITANIO GR 5** - Uno dei punti di forza della nostra linea **Resista** è il Dispositivo di Montaggio Multifunzione che viene utilizzato nelle **4** differenti applicazioni:

**1** Prelievo ed avvitamento dell'impianto - **2** Transfer per impronta Closed Tray - **3** Abutment definitivo fino a 13° di correzione angolare - **4** Mounter per Chirurgia Computer Guidata

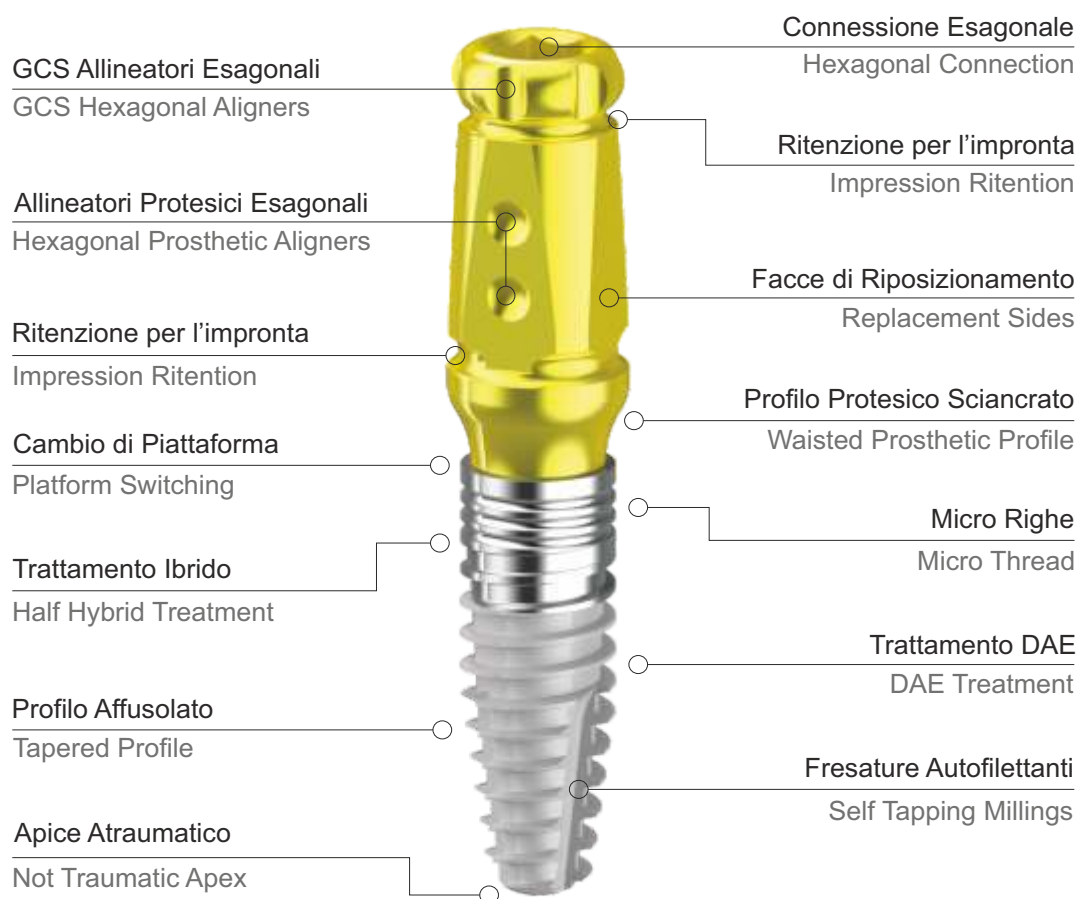

**TITANIUM GR 5 PRE-ASSEMBLED MOUNTER** - One of the strong points of our **Resista** line is the Multifunction Mounter Device that is used in the **4** following different applications:

**1** Implant pick up and screwing - **2** Closed Tray Impression Transfer - **3** Definitive Abutment up to 13° angular correction - **4** Mounter for Computer Guided Surgery

# mounter - transfer - abutment - GCS

**MOUNTER TRANSFER** - Transfer per la tecnica di impronta a **Strappo con Cucchiaino Chiuso**.

È una tecnica semplice, veloce ed efficace, adatta a tutte le tipologie di progetto protesico. Il Mounter Transfer è riposizionabile nell'impronta in un'unica posizione, definita dalle differenti facce e ritenzioni distribuite sulla superficie.

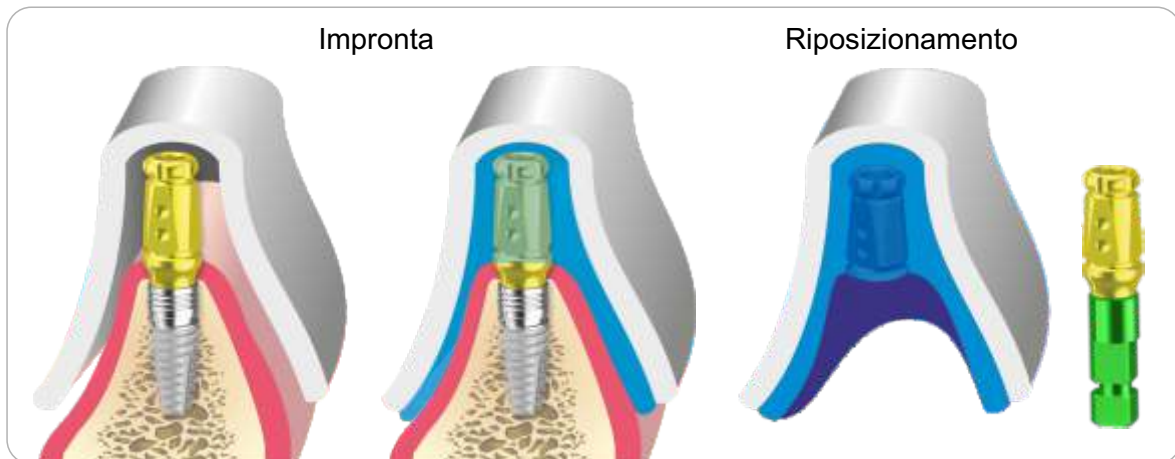

**MOUNTER ABUTMENT** - Moncone Protesico Definitivo completo di vite passante definitiva.

Il Mounter Moncone in Titanio Gr 5 è fresabile in altezza ed angolazione fino ad un massimo di 13°, utilizzando frese da laboratorio per Titanio.

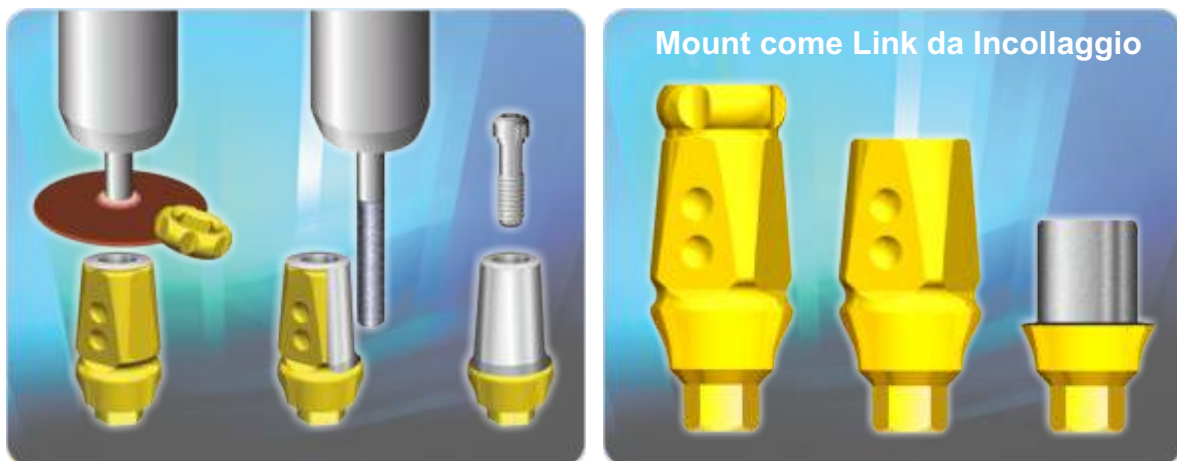

**TRANSFER MOUNTER** - Transfer for **Closed Tray Technique** (Elastic tear impression technique).

It is a simple, fast and effective technique, suitable for all types of prosthetic projects. The Transfer Mounter can be repositioned in the impression only in one position, defined by the different sides and retentions arranged on the surface.

**ABUTMENT MOUNTER** - Definitive Prosthetic Abutment complete with definitive through screw.

The Titanium Gr 5 Abutment Mounter can be milled in height and angle up to 13°, using laboratory drills for Titanium.

# mounter - transfer - abutment - GCS

**MOUNTER GCS** - Mounter adatto per l'inserimento degli impianti in **Chirurgia Computer Guidata**.

Il diametro cilindrico del Mounter scorre in asse dentro le Boccole per Chirurgia Computer Guidata, mentre i 6 riferimenti di allineamento esagonale (tacche) stabiliscono la posizione finale.



**FUNZIONE DEL MOUNTER ALL'INTERNO DELLA CONFEZIONE** - Mantiene sollevato l'impianto dentro la confezione.

Il Mounter e l'impianto sono contenuti nella **Boccola in Titanio** che garantisce la qualità della superficie durante la rimozione in fase chirurgica, evitandone la contaminazione da strisciamento.

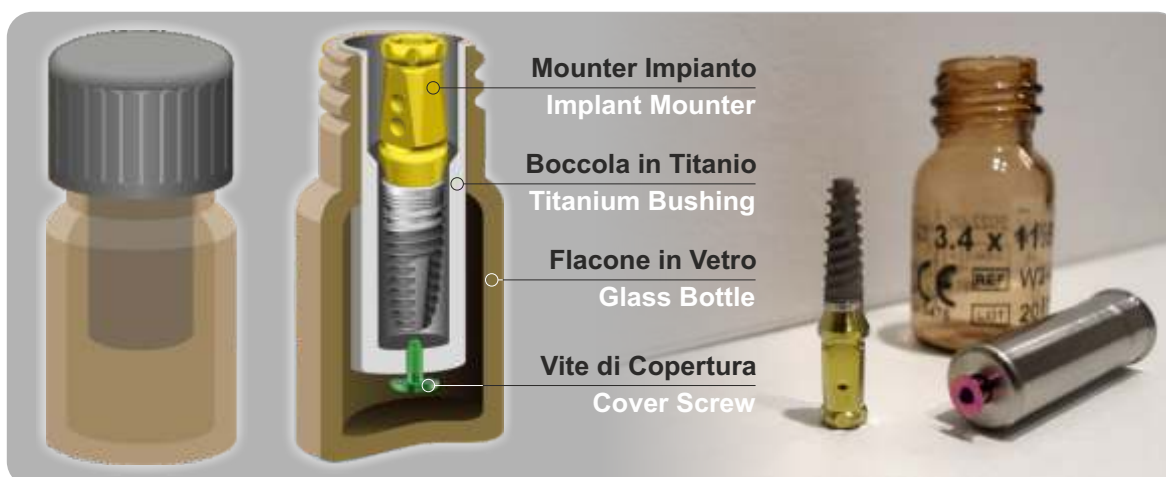

**GCS MOUNTER** - Mount suitable for implants placement by **Computer Guided Surgery**.

The cylindrical diameter of the Moulder glides on the axis inside the Bushings for Computer Guided Surgery, whereas the 6 hexagonal alignment reference points (notches) define the final position.

**MOUNTER FUNCTION INSIDE THE PACKAGING** - Hangs the implant inside the packaging.

The **Titanium Bushing** contains the Moulder and the implant and guarantees the quality of the surface during the removal surgical step, avoiding the contamination due to the scratching.

# tooth - implant ratio

## Resistenza Meccanica Implantare ed Indicazioni d'uso Implants Mechanical Resistance and Indications for Use

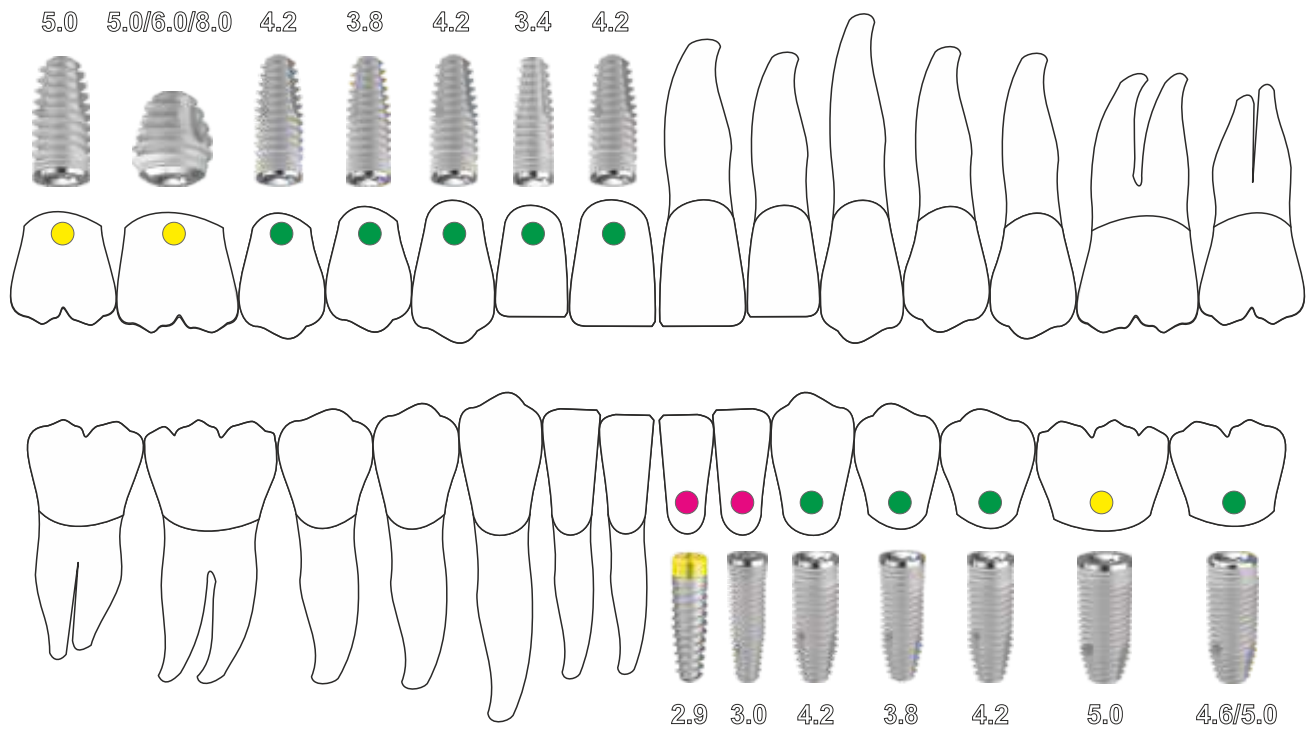

## Esempi di Protesi Mista Denti/Impianti Bilanciata Examples of Balanced Teeth/Implants Prosthetics Mixed

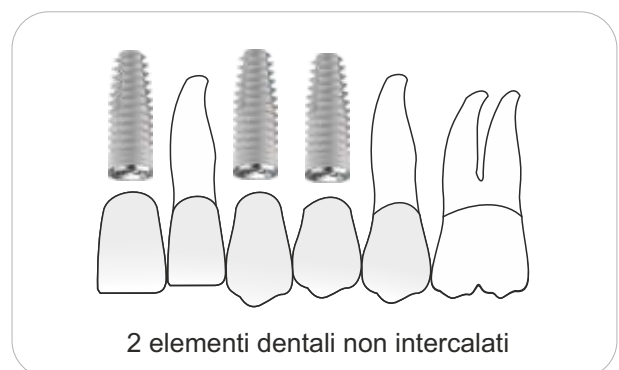
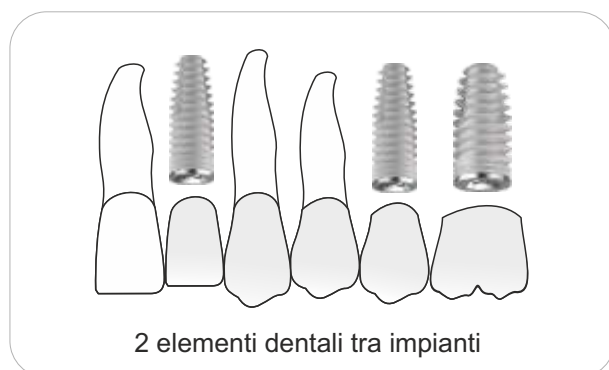
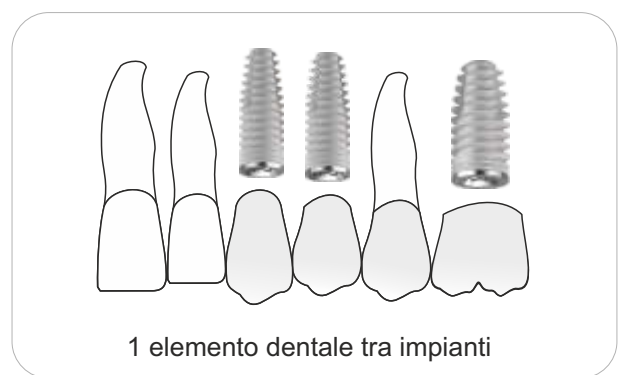
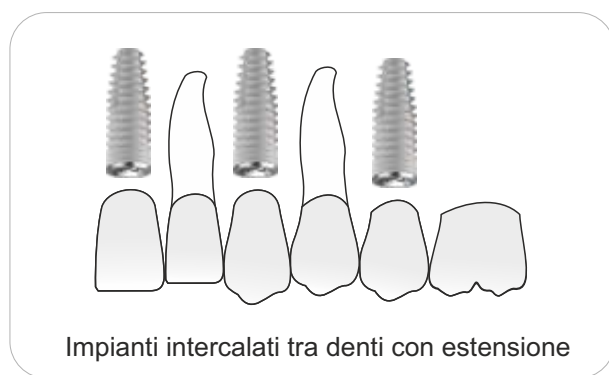

# instruments & torque

## Limiti sullo Scambio delle Forze tra Impianti e Strumenti Implants and Instruments Limits on Forces Exchanges

### INTERNAL HEXAGON

Max 50 Ncm<sup>2</sup>

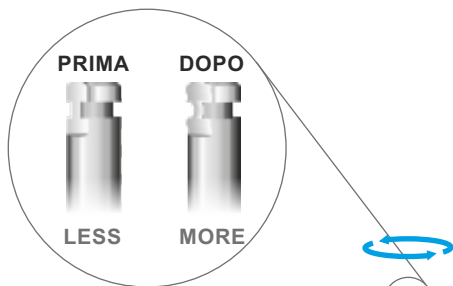

Max 150 Ncm<sup>2</sup>

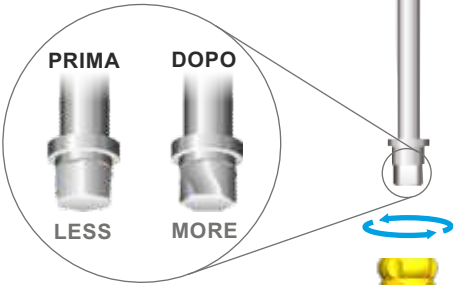

Max 120 Ncm<sup>2</sup>

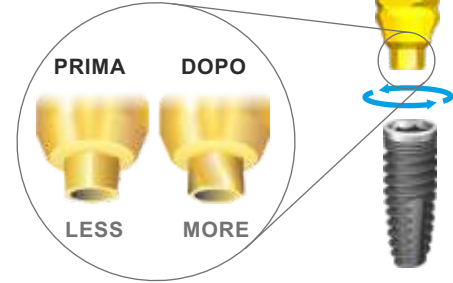

### EXTERNAL HEXAGON

Max 50 Ncm<sup>2</sup>

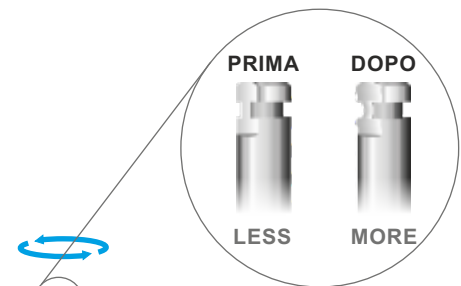

Max 150 Ncm<sup>2</sup>

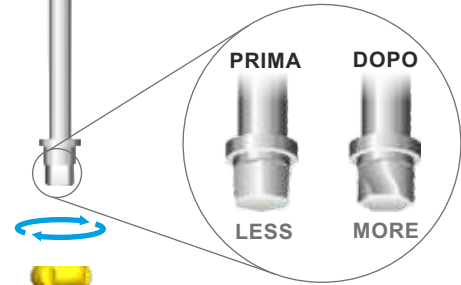

Max 70 Ncm<sup>2</sup>

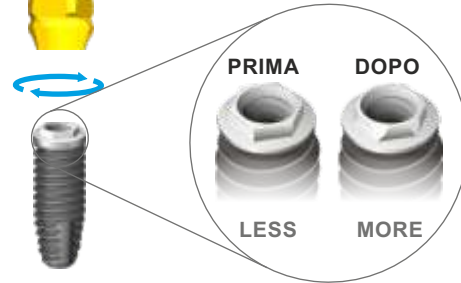

### SCREW DRIVER HEXAGON

Max 40 Ncm<sup>2</sup>

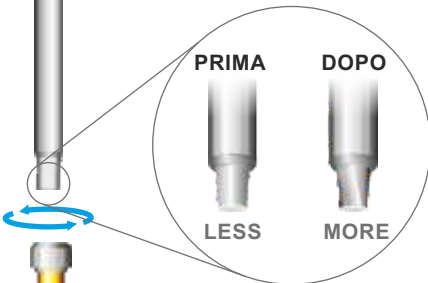

EPMV - Mini Vite Toronto **15 Ncm<sup>2</sup>**



IPVIT - Viti Protesiche **32 Ncm<sup>2</sup>**



IPVITG - Viti Protesiche **32 Ncm<sup>2</sup>**



EPVITG - Viti Protesiche **32 Ncm<sup>2</sup>**



EPVITB - Vite Protesica **32 Ncm<sup>2</sup>**



# micro geometry

## Il trattamento di superficie Micro-Nano Ruvido DAE accelera i processi di guarigione ossea

1. Rimuove i residui organici di lavorazione in combinazione con la Decontaminazione al Plasma d'Argon
2. Arrotonda gli angoli vivi eliminando i micro-difetti
3. Incrementa la superficie e la bagnabilità (idrofilia superficiale), migliorando l'adesione dei primi ponti di fibrina
4. Aumenta l'adesione proteica
5. Massimizza l'adesione cellulare con rugosità Micro-Nano Metriche ideali per l'ancoraggio dei filamenti di actina (filopodi)
6. Cambia la chimica superficiale del Titanio che migliorando in biocompatibilità incrementa la proliferazione e la vitalità cellulare

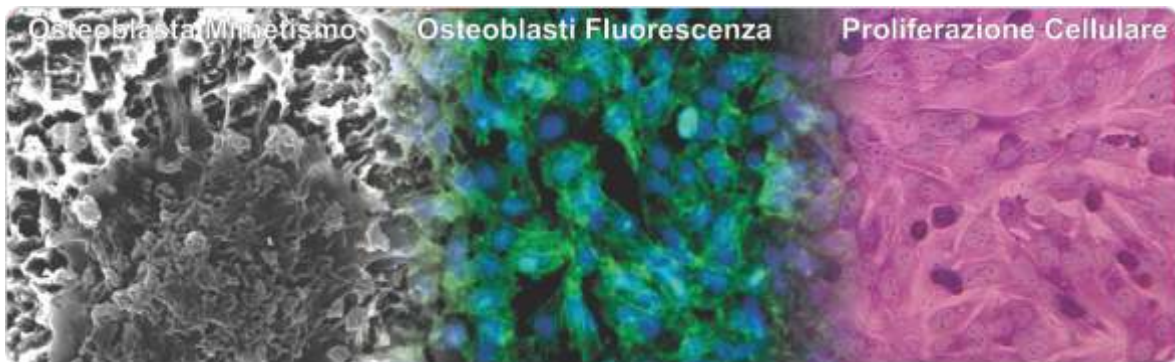

## La topografia e la chimica di superficie interagiscono con i processi di differenziazione cellulare

La superficie implantare usa la microtopografia come linguaggio di comunicazione con le cellule del tessuto ospite. La pulizia in reattore al plasma freddo di Argon con confezionamento in ambiente controllato nell'assoluto rispetto delle procedure, gioca un ruolo fondamentale nel controllo delle endotossine adese (principale agente di risposta immunologica alle superfici implantari).

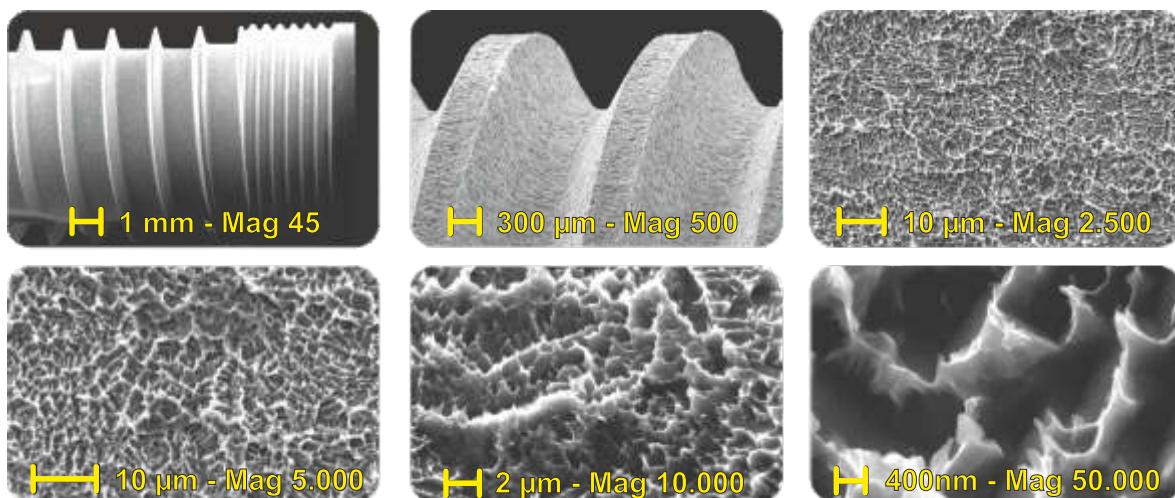

## The Micro-Nano Rough DAE surface treatment speed up bone healing processes

1. Removes the manufacturing organic residuals along with Argon Plasma Cleaning
2. Smooths the edge and eliminates the micro-defects
3. Increases surface and wettability (hydrophilicity surface), improving the first fibrin bridges adhesion
4. Increases protein adhesion
5. Maximizes cellular adhesion through the Micro-Nano roughness suitable for actin filaments (phyllopods) anchoring
6. Changes the Titanium surface chemical characteristics improving the biocompatibility and increasing the cellular proliferation and vitality

## Surface topography and chemistry interact with the cellular differentiation processes

The implant surface uses the microtopography as a communication language with the host tissue cells. The Plasma Argon Cold Cleaning with a controlled-environment packaging at a strict protocol procedures, play a key-role in the control of adhered endotoxins (main immunological response player to implant surfaces).

# micro geometry - 4 treatments

## DISTRIBUZIONE DEL TRATTAMENTO DI SUPERFICIE SULLA FORMA IMPLANTARE

Tutti gli impianti **Resista** presentano un trattamento di superficie localmente differenziato. La logica di distribuzione superficiale del trattamento è dettata dalla posizione endo-ossea dell'impianto che richiede caratteristiche differenti in funzione della presenza, più o meno ravvicinata della componente mucogengivale.

- 1. Superficie Machined:** Spazzolata, rettificata e mascherata nel processo di irruvidimento
- 2. Superficie Nanoruvida:** Trattamento veloce, nanoruvido con Ra medio inferiore al micron
- 3. Superficie Microruvida 3/5 $\mu$ :** Trattamento DAE, microruvido con Ra medio tra 3/5 micron
- 4. Superficie Microruvida 4/7 $\mu$ :** Trattamento DAE lento, microruvido con Ra medio tra 4/7 micron

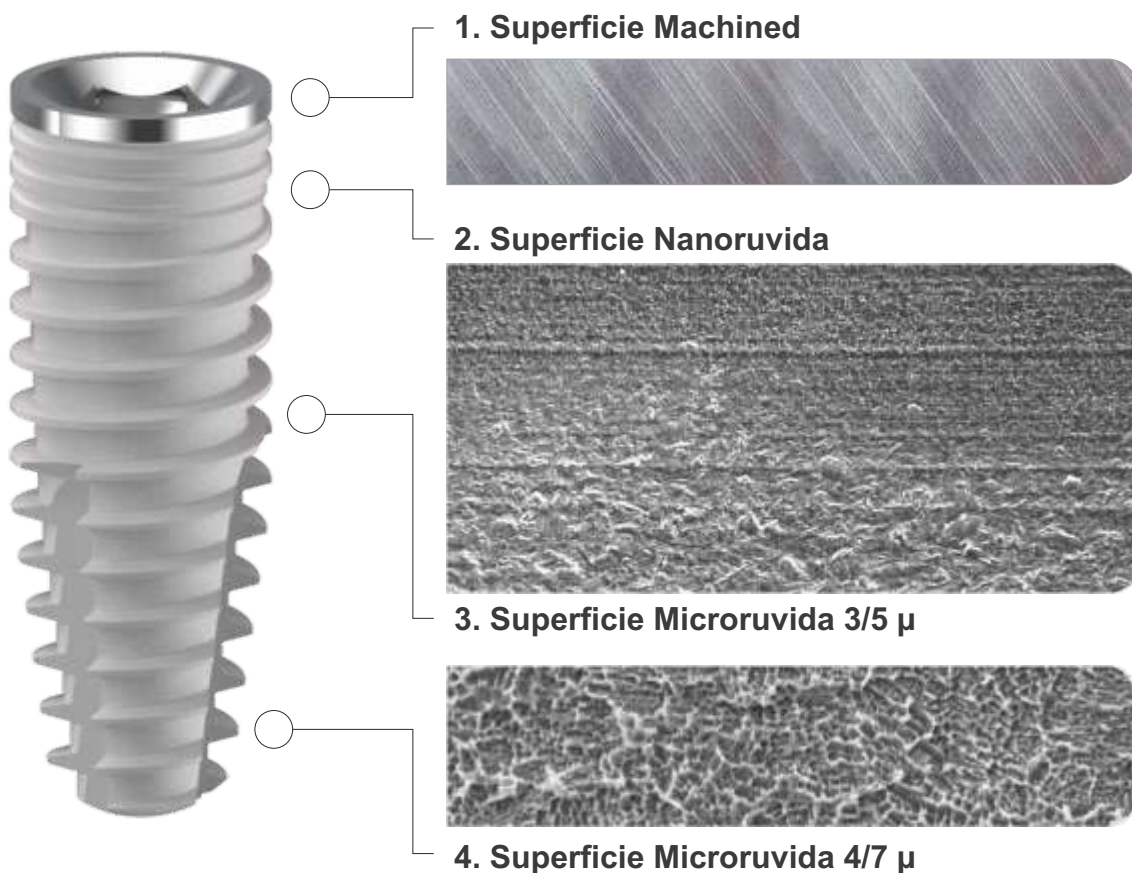

**VEGF/VEGF-R/RUNX2 Upregulation in Human Periodontal Ligament Stem Cells Seeded on Dual Acid Etched Titanium Disk**

Francesca Diomede, Guya Diletta Marconi, Marcos F. X. B. Cavalcanti, Jacopo Pizzicannella, Sante Donato Pierdomenico, Luigia Fonticoli, Adriano Piattelli and Oriana Trubiani

Materials 2020, 13, 706; doi:10.3390/ma13030706



## SURFACE TREATMENT DISTRIBUTION ON IMPLANT'S BODY

All the **Resista**'s implants have a surface treatment that is locally differentiated. The logic of surface treatment distribution is dictated by the endo-osseous implant position which requires different characteristics dependin on the muco-gingival component presence around.

- 1. Machined Surface:** Brushed, rectify and protected during the roughening process
- 2. Nano-rough Surface:** Speedy treatment, nano-rough with average Ra less than one micron
- 3. Micro-rough Surface: 3/5 $\mu$ :** DAE Treatment, micro-rough with average Ra between 3/5 $\mu$
- 4. Micro-rough Surface: 4/7 $\mu$ :** DAE Slow Treatment, micro-rough with average Ra between 4/7 $\mu$

## PUNTI DI FORZA DELLA LINEA IMPLANTARE RESISTA

- 1. Macro Geometrie:** Vastissima gamma di forme implantari per le differenti necessità in campo chirurgico (Cilindrici, Tapered, Attivi, Short, Mini ed Extra-Larghi)
- 2. Micro Geometrie:** Trattamenti di superficie differenziati (Full, Half e Machined) di ultima generazione (DAE Micro e Nano rugosi), decontaminati in Reattore al Plasma Freddo di Argon.



### The Bacterial Anti-Adhesive Activity of Double-Etched Titanium (DAE) as a Dental Implant Surface

Morena Petrini, Alessandra Giuliani, Emanuela Di Campi, Silvia Di Lodovico, Giovanna Iezzi, Adriano Piattelli and Simonetta D'Ercole<sup>1</sup>  
International Journal of Molecular Sciences 2020, 21, 8315; doi:10.3390/ijms21218315

- 3. Mounter Multifunzione:** 4 componenti in un unico articolo (Mounter, Transfer, Abutment e Mounter per Chirurgia Computer Guidata) per massimizzare la resa ed ottimizzare i costi.
- 4. Componenti protesiche:** Vastissima gamma di varianti protesiche con tolleranze di lavorazione sulle connessioni di 7 micron, con profili emergenti curvilinei, connessioni piane e coniche, platform switching, viti in Titanio Dorate e rivestimenti in PVD TiN (più estetica e minore ritenzione di placca).
- 5. Strumentario Chirurgico:** Frese chirurgiche **3-Tech**, massima efficienza, minima invasività, basso coefficiente di attrito, tecnologia **PRO MSD** per applicazione osseo-densificante in senso antiorario, lunga durata, perfetta visibilità delle tacche laser e stop chirurgici millimetrati.



## THE RESISTA'S IMPLANT LINE STRONG POINTS

- 1. Macro Geometry:** A vast range of implant shapes for different surgical needs (Cylinder, Tapered, Active, Short, Mini and Extra-Large)
- 2. Micro Geometry:** Last Generation Differentiated Surface (Full, Half and Machined) treated (DAE Micro and Nano rough), decontaminated in Argon Cold Plasma Reactor.
- 3. Multifunctional Mounter:** 4 components in a single article (Mounter, Transfer, Abutment and Mounter for Computer Guided Surgery) to maximize result and minimize costs.
- 4. Prosthetic Parts:** A very wide range of prosthetic variants with 7/10 micron machining tolerances on the connection, with emerging curvilinear profiles, flat and conical connections, platform switching, golden titanium screws and PVD TiN coatings (more aesthetic and less retention of dental plaque).
- 5. Surgical Instruments:** Surgical Drills **3-Tech**, maximum efficiency, minimum trauma, smaller friction coefficient, **PRO MSD** technology for counterclockwise bone densifying application long, lasting resistance, perfect visibility of laser marking and surgical millimeters stop.

# technology

## COERENZA E LOGICA NEL RAPPORTO DIAMETRO FRESA/DIAMETRO NOCCIOLO-IMPIANTO

Le progettazioni della forma degli strumenti rotanti si basa sulla logica coerenza tra la dimensione degli impianti, nell'ingombro esterno, nel nocciolo interno e per la loro capacità di penetrazione.

Gli **impianti cilindrici** della linea **IC** presentano una porzione apicale affusolata per una lunghezza di 3mm. Gli **impianti conici** della linea **IK** presentano una porzione apicale affusolata per una lunghezza di 5mm.

Le frese si presentano rispettivamente con 2 / 3 sezioni apicali, adeguate per una preparazione del tunnel implantare rispetto alla geometria dell'impianto, mantenendo il miglior BIC di interfaccia osso / impianto.

Ogni gradino è fornito di un tagliente affilato per agevolare la penetrazione, minimizzando l'attrito ed il surriscaldamento

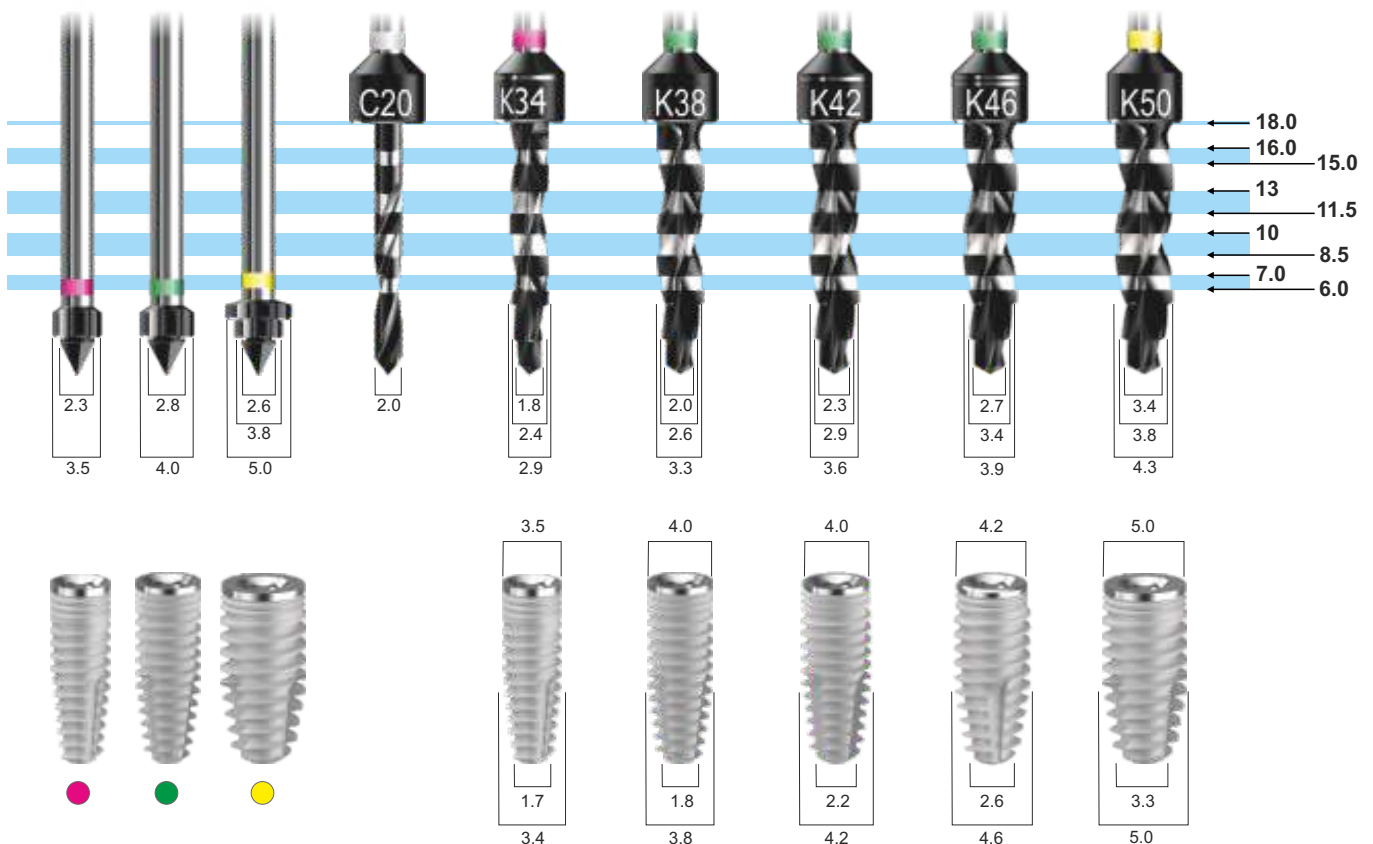

### Various bio-mechanical factors affecting heat generation during osteotomy preparation: A systematic review

Chirag J Chauhan<sup>1</sup>, Darshana N Shah<sup>1</sup>, Foram B Sutaria<sup>1</sup>

Indian J Dent Res. Jan-Feb 2018;29(1):81-92. doi: 10.4103/ijdr.IJDR\_729\_16.



## LOGIC RELATION BETWEEN DRILL AND IMPLANT CORE

The rotary instruments design and shape is based on the logical coherence between the implants size, in the external dimensions, internal core and their penetration properties.

The **IC** line **Cylindrical Implants** have a tapered apical portion 3mm long.

The **IK** line **Conical Implants** have a tapered apical portion 5mm long.

The drills have respectively 2/3 apical sections, suitable for the implant tunnel preparation, with respect to the implant geometry, maintaining the best bone implant contact (BIC).

Each step drill is equipped with a sharp cutting edge to facilitate penetration, minimizing friction and overheating.

# PRO MSD drilling technology

## IL CONDIZIONAMENTO DEI PROTOCOLLI CHIRURGICI

Le geometrie implantari differenziate nella macro/micro forma, prevedono applicazioni diverse sia in funzione delle necessità chirurgico/protesiche (carico immediato, carico precoce o carico posticipato) sia in base alle condizioni della componente ossea/anatomica del paziente da riabilitare.

Tuttavia, si richiedono spesso indispensabili manovre chirurgiche e protocolli alternativi per migliorare le prestazioni implantari in funzione delle caratteristiche morfologiche delle strutture ossee residue.

La riuscita di tali manovre, come risultato di applicazioni combinate di strumenti e protocolli personalizzati, rappresenta la differente risposta al problema in relazione alle personali capacità operatorie ed alla presenza più o meno marcata di strumenti e mezzi adeguati all'applicazione delle stesse.

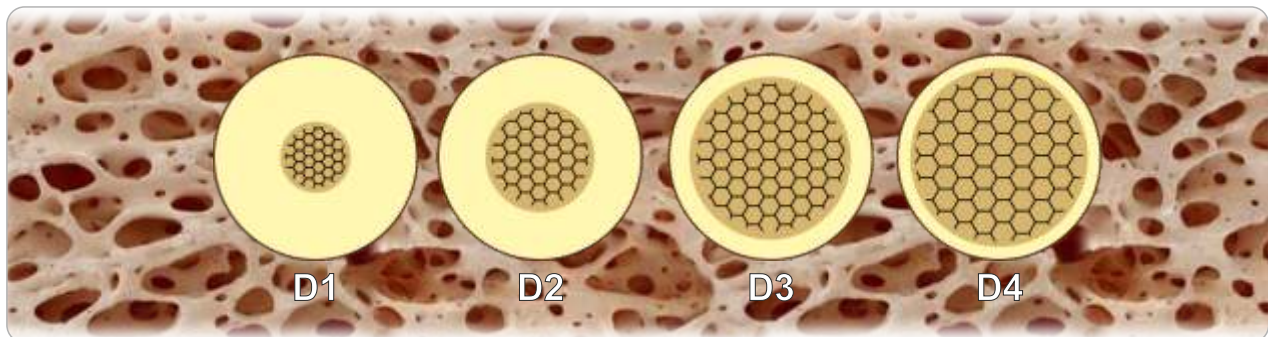

### Bone classification: clinical-histomorphometric comparison

Trisi P, Rao W. - Clin Oral Implants Res. 1999 Feb;10(1):1-7. doi: 10.1034/j.1600-0501.1999.100101.x.

## OSSEODENSIFICAZIONE MECCANICA IN ROTAZIONE ANTIORARIA

L'osseodensificazione tramite strumenti rotanti è una recente tecnica chirurgica per la preparazione del sito implantare che può essere associata a differenti protocolli, applicabili in quelle particolari condizioni anatomiche dove la qualità ossea risulta scarsa e con dimensioni verticali / orizzontali insufficienti.

Questo approccio di osseo-condensazione osteotomica non sottrattiva, genera un aumento della densità ossea peri-osteotomica, con il risparmio del tessuto stesso e l'incremento della stabilità primaria implantare.



## THE CONDITIONING OF SURGICAL PROTOCOLS

The differentiated implant geometries in the macro/micro shape provide for different applications, both according to the surgical/prosthetic requirements (immediate loading, early loading or postponed loading) and according to the conditions of the bone/anatomical component of the patient who needs rehabilitation. However, surgical maneuvers and alternative protocols are often required to improve implant performance, according to the morphological characteristics of the residual bone structures.

The success of these maneuvers, that is often the result of a customized tools and protocols combination, represents the different response to the problem in relation to the personal operating skills and the presence of tools suitable for their application.

## MECHANICAL OSSEODENSIFICATION IN ANTI-CLOCKWISE ROTATION

The osseodensification using rotary instruments is a recent surgical technique for the implant site preparation that can be associated with different protocols; these protocols can be used in those particular anatomical conditions such as poor bone quality and insufficient vertical / horizontal dimensions.

This non-subtractive osteotomic bone-condensation approach produces an increase in peri-osteotomic bone density, saving the tissue and increasing the primary implant stability.

# PRO MSD drilling technology

## FRESE CHIRURGICHE RESISTA PRO MSD - Modular Surgical Drilling

Le Frese Chirurgiche Modulari a geometria variabile sono frese elicoidali a 3 sezioni con spoglia raggiata progressiva, utilizzabili in senso **orario** ed **antiorario**.

Il diametro di ogni fresa varia, con un rapporto costante, di 0,4mm (30/34/38/42/46/50), permettendo così all'operatore la scelta di utilizzo in funzione della qualità ossea (sovra-preparazione o sotto-preparazione).

Tutte le frese sono rivestite con un coating di lubrificante solido in diamante sintetico DLC (Diamond Like Carbon) che massimizza le prestazioni in termini di resistenza meccanica e riduzione dell'attrito.

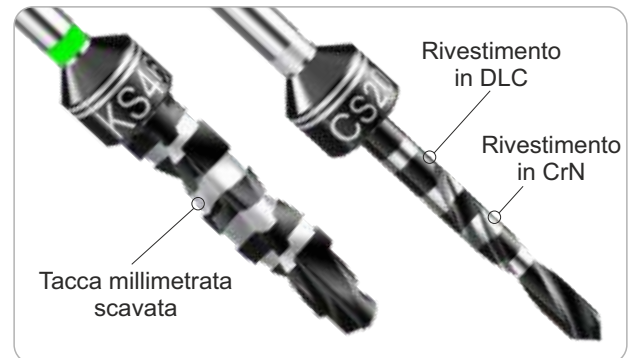
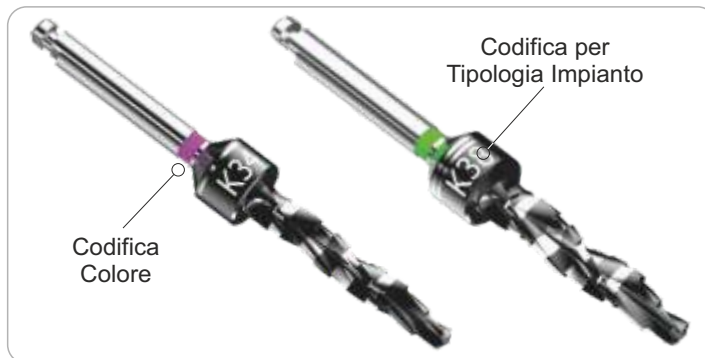

## ROTAZIONE ANTIORARIA

La rotazione antioraria, invertendo le forze in gioco, genera 3 effetti differenti sulla pratica chirurgica di preparazione del tunnel implantare, che possono rivoluzionare la logica di fresatura conosciuta.

- 1) Spinta anteriore e laterale dell'osso asportato dalla punta più tutti i liquidi in gioco, sangue e fisiologica.
- 2) Espulsione ad "effetto martello" della fresa, con un miglioramento del controllo verticale.
- 3) Riduzione dell'efficienza di taglio a salvaguardia delle parti anatomiche sensibili.

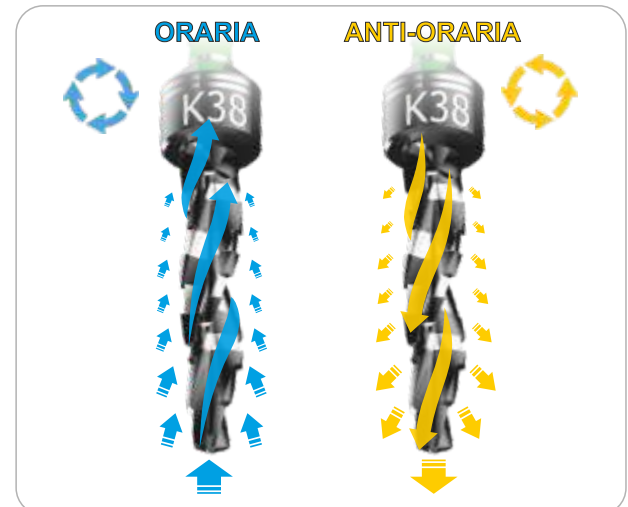

## RESISTA PRO MSD SURGICAL DRILLS - Modular Surgical Drilling

The Modular Surgical Drills with variable geometry are 3-section helicoidal drills with progressive radius rake, that can be used clockwise and anticlockwise.

The diameter of each drill changes according to a constant ratio of 0.4mm (30/34/38/42/46/50): this allows the operator to choose the drill according to the bone quality (over-preparation or under-preparation). All the drills are coated with a DLC (Diamond Like Carbon) synthetic diamond solid lubricant that maximizes performance in terms of mechanical strength and friction reduction.

The **anticlockwise rotation**, reversing the involved forces, generates 3 different effects on the implant tunnel perforation, which can revolutionize the known milling logic.

- 1) Anterior and lateral thrust of the bone removed by the tip, and of the liquids as well, blood and physiological water.
- 2) Ejection and "hammer effect" of the drill that produce an improvement in vertical control.
- 3) Reduction of cutting efficiency to protect sensitive anatomical parts.

# UNI-Q-MUA

## ONE PIECE TRANSGINGIVAL IMPLANT

### UNI-Q-MUA TAPERED SHAPE

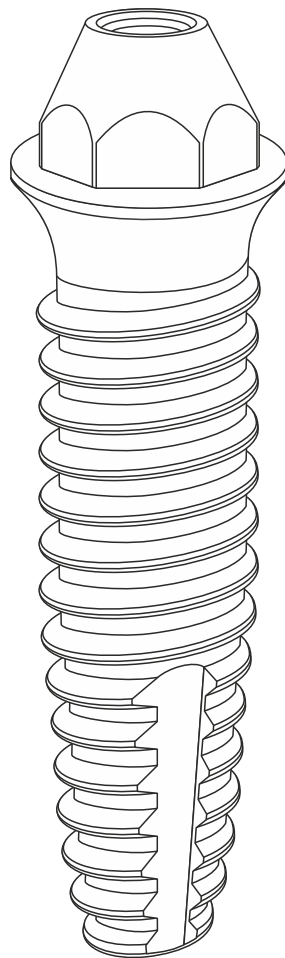

MMF

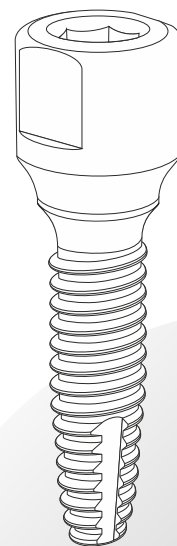

IMPIANTO  
CON MOUNTER  
WITH MOUNTER

# UNI-Q-MUA

## 3 TREATMENT SURFACE



PVD TiN



Machined

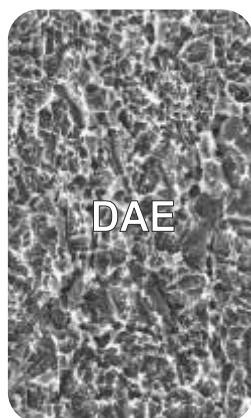

DAE



DAE

**Bone healing around titanium and titanium nitride-coated dental implants with three surfaces: an experimental study in rats.** Scarano A, Piattelli M, Vrespa G, Petrone G, Iezzi G, Piattelli A. - Clin Implant Dent Relat Res. 2003

**Bacterial adhesion on titanium nitride-coated and uncoated implants: an in vivo human study.** Scarano A, Piattelli M, Vrespa G, Caputi S, Piattelli A. - J Oral Implant. 2003

**Cytocompatibility of implants coated with titanium nitride and zirconium nitride.** Prachar P, Bartakova S, Brezina V, Cvrcek L, Vanek J. - Bratisl Lek Listy. 2015

**Evaluation of antibacterial activity and osteoblast-like cell viability of TiN, ZrN and (Ti1-xZrx)N coating on titanium.** Ji MK, Park SW, Lee K, Kang IC, Yun KD, Kim HS, Lim Hp. - J Adv Prosthodont. 2015

**Surface properties correlated with the human gingival fibroblasts attachment on various materials for implant abutments: a multiple regression analysis.** Kim YS1, Shin SY, Moon SK, Yang SM. - Acta Odontol Scand. 2015

**Machined and sandblasted human dental implants retrieved after 5 years: a histologic and histomorphometric analysis of three cases.** Iezzi G, Vantaggiato G, Shibli JA, Fiera E, Falco A, Piattelli A, Perrotti V. - Quintessence Int. 2012

**Polyspecies biofilm formation on implant surfaces with different surface characteristics.** Schmidlin PR, Müller P, Attin T, Wieland M, Hofer D, Guggenheim B. - J Appl Oral Sci. 2013

**Red blood cell and platelet interactions with titanium implant surfaces.** Park JY, Davies JE. - Clin Oral Implants Res. 2000

**Surface chemistry effects of topographic modification of titanium dental implant surfaces. 2: In vitro experiments.** Morra M, Cassinelli C, Bruzzone G, et al. - Int J Oral and Maxillofac Implants 2003

**Surface microtopography regulates osteointegration: the role of implant surface microtopography in osteointegration.** Schwartz Z1, Nasazky E, Boyan BD. - 2005

**A new chemical etching process to improve endosseous implant osseointegration: in vitro evaluation on human osteoblast-like cells.** Giordano C, Sandrini E, Busini V, Chiesa R, Furnagalli G, Giavaresi G, Fini M, Giardino R, Cigada A. - Int J Artif Organs. 2006

**Enhancing surface free energy and hydrophilicity through chemical modification of microstructured titanium implant surfaces.** Morra M, Volpe CD, Siboni S, by F. Rupp, L. Scheideler, N. Olshanska, M. de Wild, M. Wieland, J. Geis-Gerstorfer. - J Biomed Mater Res A. 2006

**Assessing double Acid-etched implants submitted to orthodontic forces and used as prosthetic anchorages in partially edentulous patients.** De Cravero Marta R1, Carlos IJ. - Open Dent J. 2008.

**Mechanical stability of immediately loaded implants with various surfaces and designs: a pilot study in dogs.** Neugebauer J, Weinländer M, Lekovic V, von Berg KH, Zoeller JE. Int J Oral Maxillofac Implants. 2009

**Influence of implant shape, surface morphology, surgical technique and bone quality on the primary stability of dental implants.** Elias CN1, Rocha FA, Nascimento AL, Coelho PG. - J Mech Behav Biomed Mater. 2012

**Early-loaded laser-sintered versus acid-etched one-piece dental implants for mandibular premolars replacement: a preliminary study.** El-Gammal M1, Ghoneem N, Tawfik H, Madina MA, Fadhil ON, Maria OM. Implant Dent. 2014

**Dual-etched implants loaded after 1- and 2-month healing periods: a histologic comparison in baboons.** Vermino AR, Kohles SS, Holt RA Jr, Lee HM, Caudill RF, Kenealy JN. Int J Periodontics Restorative Dent 2002

**Early endosseous integration enhanced by dual acid etching of titanium: a torque removal study in the rabbit.** Klokkevold P, Johnson P, Dadgostari S, Caputo A, Davies JE, Nishimura R. Clin Oral Implants Res 2001

### 3 TRATTAMENTI DI SUPERFICIE

1) Rivestimento transgingivale e protesico in PVD TiN - *Maggiore resistenza meccanica all'usura, proprietà antibatteriche, riduzione dell'adesione del biofilm batterico.*

2) Superficie Ibrida Macchinata per 1.5mm - *Riduzione dell'adesione del biofilm batterico per il controllo delle perimplantiti.*

3) Superficie Doppia Acidificazione DAE - *Incremento della superficie, rimozione dei microdifetti ed uniformazione, incremento dell'idrofilia superficiale, incremento dell'adesione dei ponti di fibrina, idealizzazione del substrato per l'adesione cellulare, attivazione della comunicazione topografica per l'espressione genica cellulare/osteoblastica, incremento dell'attività antibatterica bio-elettrica.*

# UNI-Q-MUA

## TORONTO PROSTHETICS - BRIDGES AND CROWNS

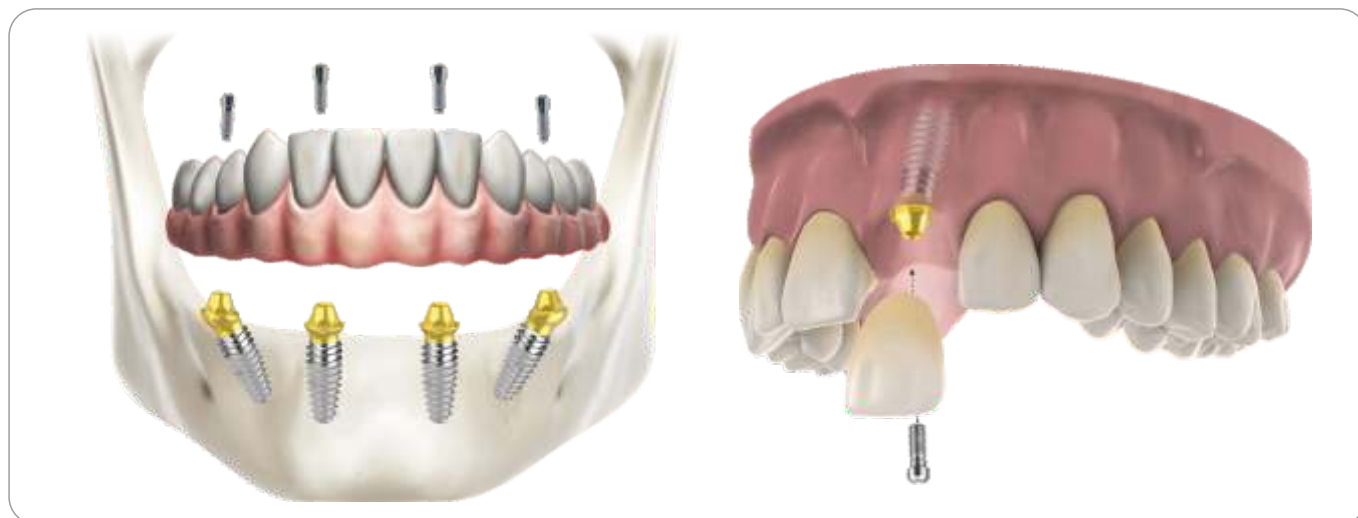

### UNI-Q-MUA 2.0

Evoluzione del progetto originale UNI-Q-MUA del 2015, sviluppato e migliorato dal nostro reparto di R&D per un applicazione chirurgica a 360°.

Nato per la realizzazione e semplificazione della protesi tipo Toronto, allarga il suo campo di applicazione alle corone e ponti. Con un collo trans-gengivale di 1,5mm ed una piattaforma protesica anti-rotazionale esagonale, permette il serraggio diretto anche di una singola corona avvitata.

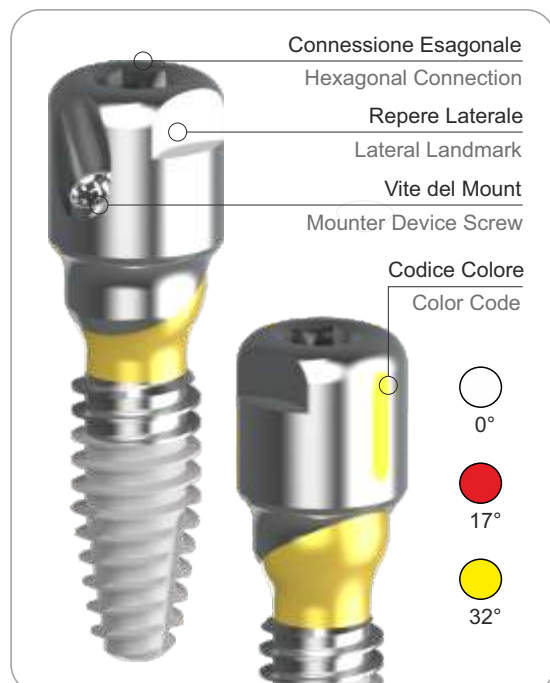

### UNI-Q-MUA 2.0

Born for the Toronto-type prosthetics realization and simplification, it extends its application field to crowns and bridges. With a 1.5mm trans-gingival neck and a hexagonal anti-rotational prosthetic platform, it allows direct tightening of even a single screwed crown.

# MMFS 34

## UNI-Q-MUA straight one piece transgingival implant

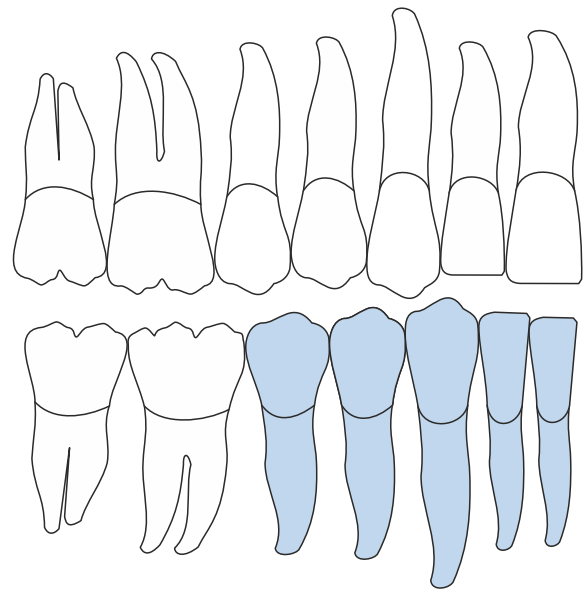
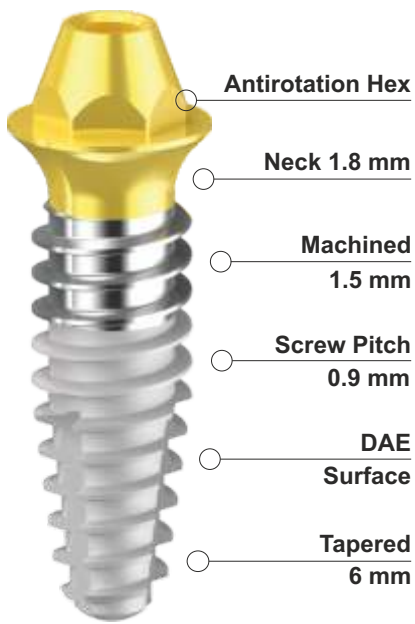

CODE	IMPLANT	LENGTH	PLATFORM	APEX
MMFS 3408	Ø 3.4	8.5 mm	0°	Ø 1.7
MMFS 3410	Ø 3.4	10 mm	0°	Ø 1.7
MMFS 3411	Ø 3.4	11.5 mm	0°	Ø 1.7
MMFS 3413	Ø 3.4	13 mm	0°	Ø 1.7

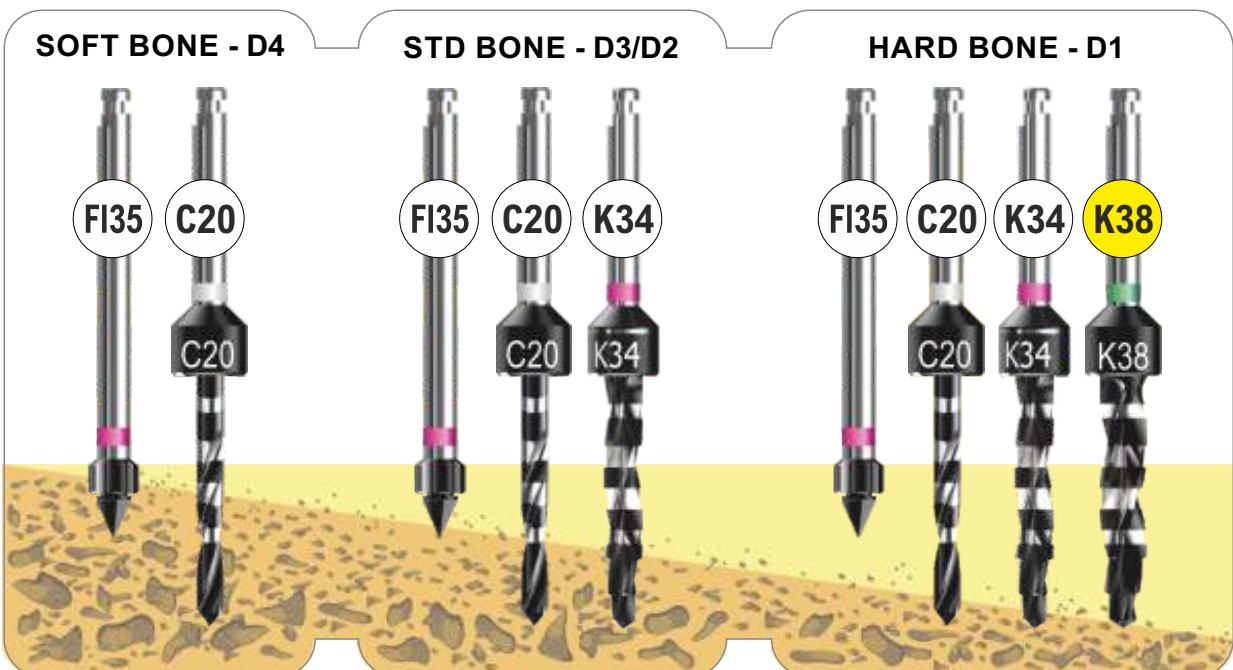

# UNI-Q-MUA angled one piece transgingival implant

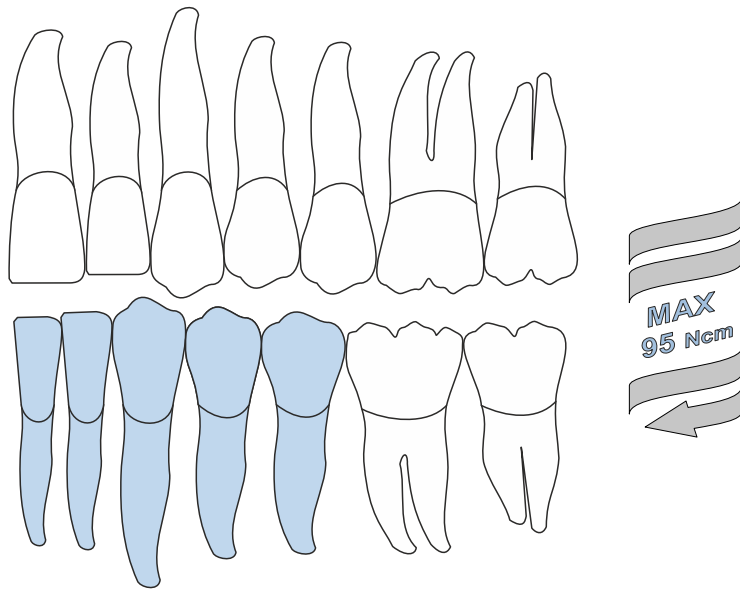

# MMFA 34

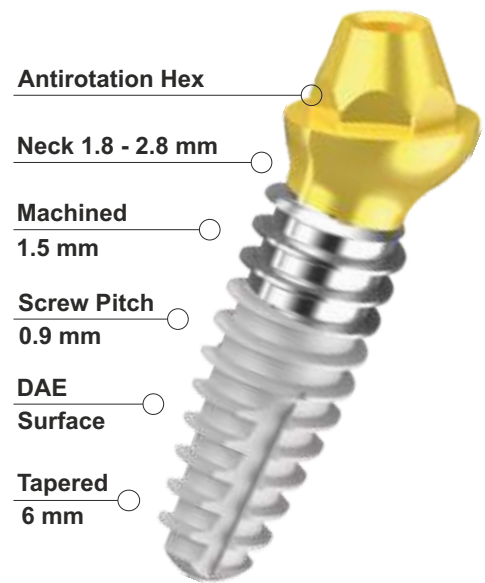

CODE	IMPLANT	LENGTH	PLATFORM	APEX
<b>MMFA 3408-17</b>	Ø 3.4	8.5 mm	17° ●	Ø 1.7
<b>MMFA 3410-17</b>	Ø 3.4	10 mm	17° ●	Ø 1.7
<b>MMFA 3411-17</b>	Ø 3.4	11.5 mm	17° ●	Ø 1.7
<b>MMFA 3413-17</b>	Ø 3.4	13 mm	17° ●	Ø 1.7
<b>MMFA 3415-17</b>	Ø 3.4	15 mm	17° ●	Ø 1.7
<b>MMFA 3408-32</b>	Ø 3.4	8.5 mm	32° ●	Ø 1.7
<b>MMFA 3410-32</b>	Ø 3.4	10 mm	32° ●	Ø 1.7
<b>MMFA 3411-32</b>	Ø 3.4	11.5 mm	32° ●	Ø 1.7
<b>MMFA 3413-32</b>	Ø 3.4	13 mm	32° ●	Ø 1.7
<b>MMFA 3415-32</b>	Ø 3.4	15 mm	32° ●	Ø 1.7

### SOFT BONE - D4

### STD BONE - D3/D2

### HARD BONE - D1

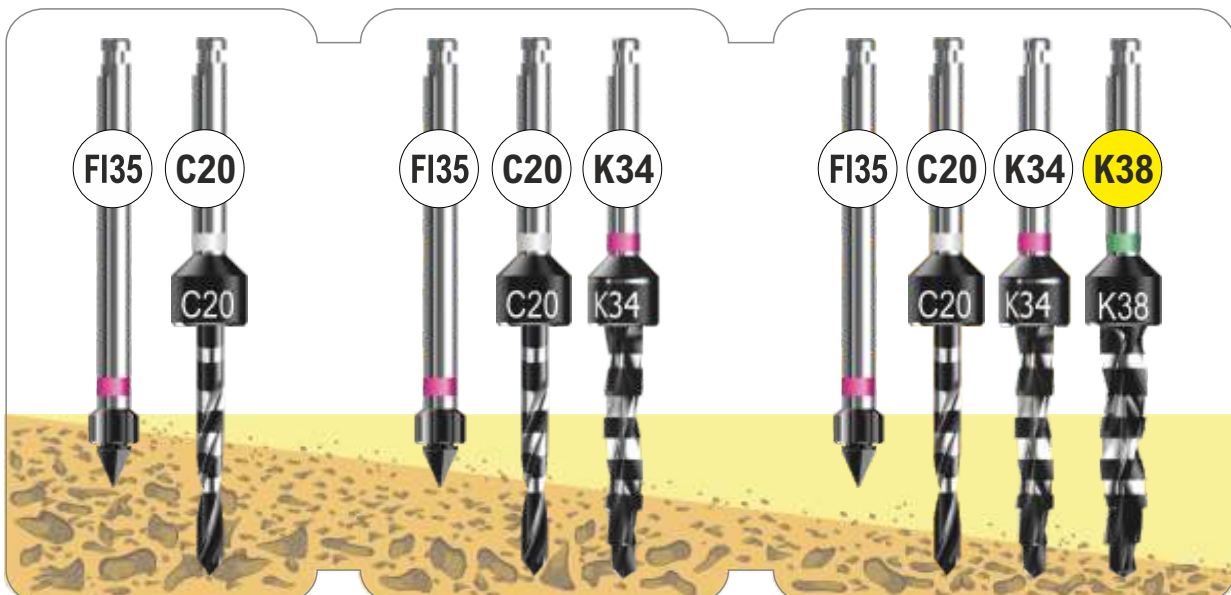

# MMFS 38

## UNI-Q-MUA straight one piece transgingival implant

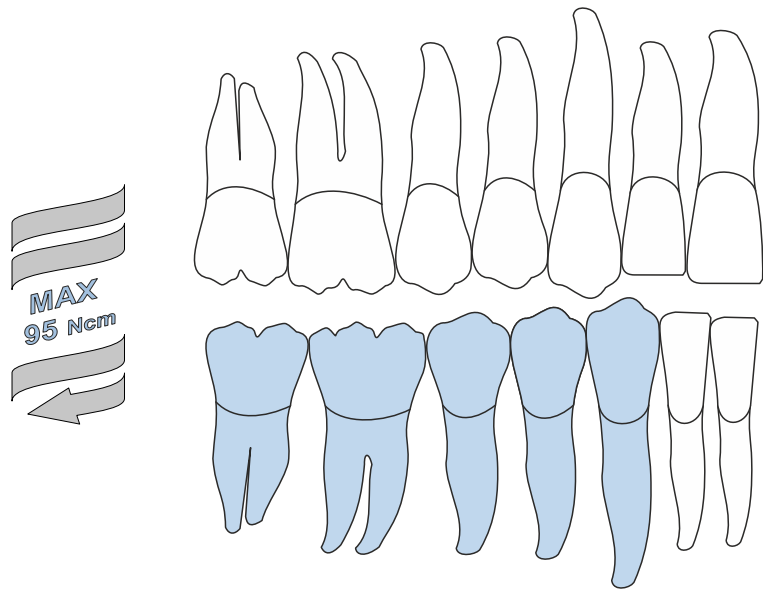
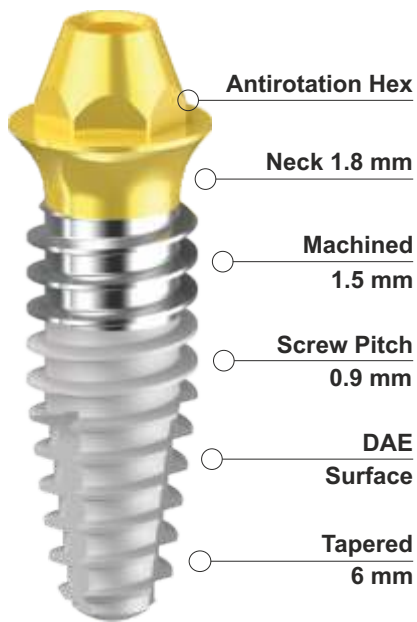

CODE	IMPLANT	LENGTH	PLATFORM	APEX
<b>MMFS 3808</b>	Ø 3.8	8.5 mm	0°	Ø 1.8
<b>MMFS 3810</b>	Ø 3.8	10 mm	0°	Ø 1.8
<b>MMFS 3811</b>	Ø 3.8	11.5 mm	0°	Ø 1.8
<b>MMFS 3813</b>	Ø 3.8	13 mm	0°	Ø 1.8
<b>MMFS 3815</b>	Ø 3.8	15 mm	0°	Ø 1.8

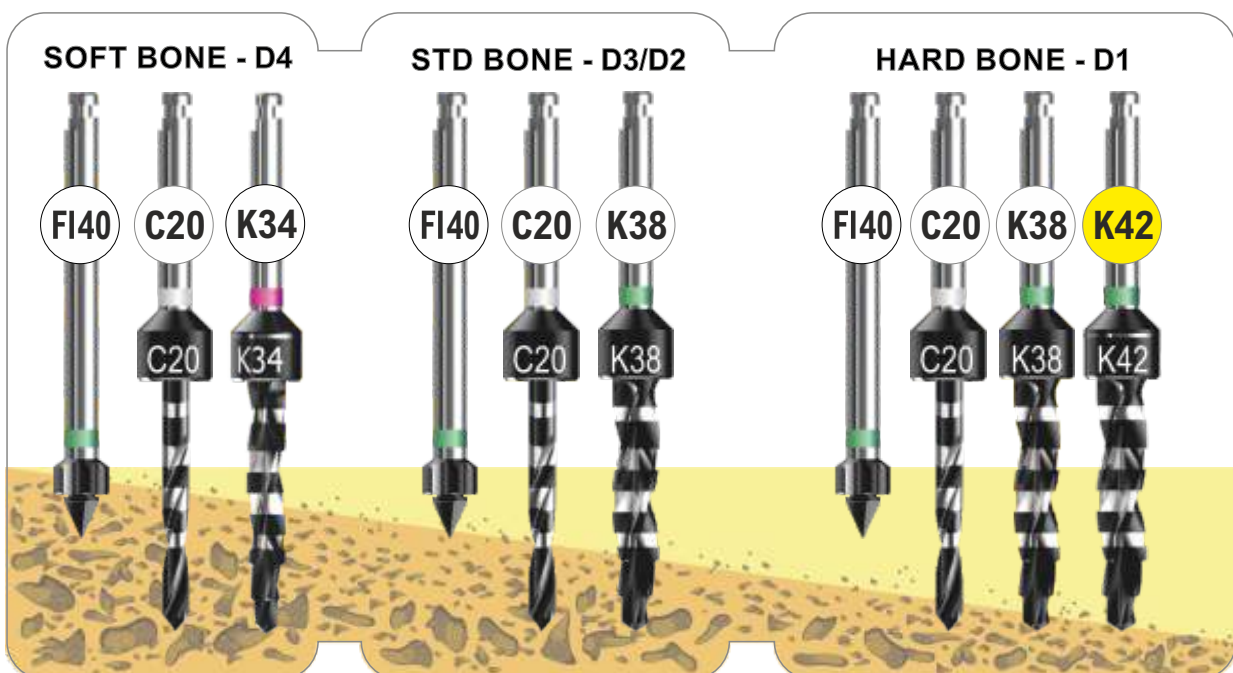

# UNI-Q-MUA angled one piece transgingival implant

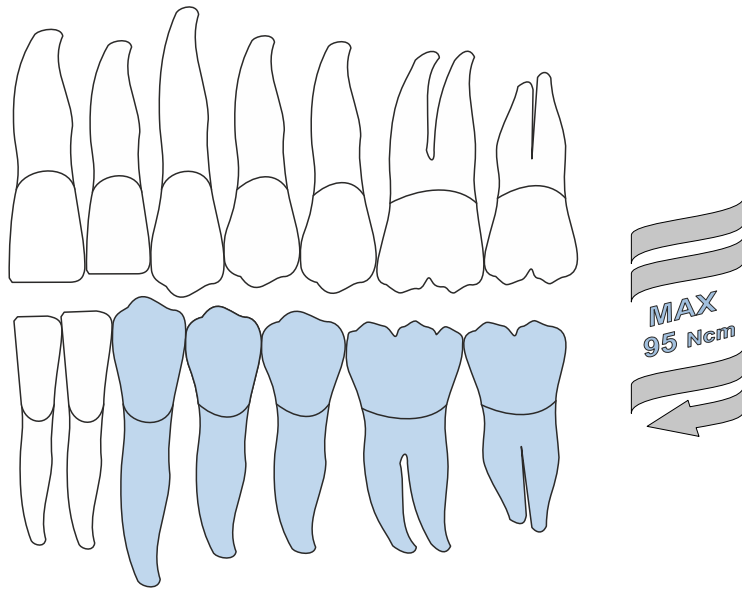

# MMFA 38

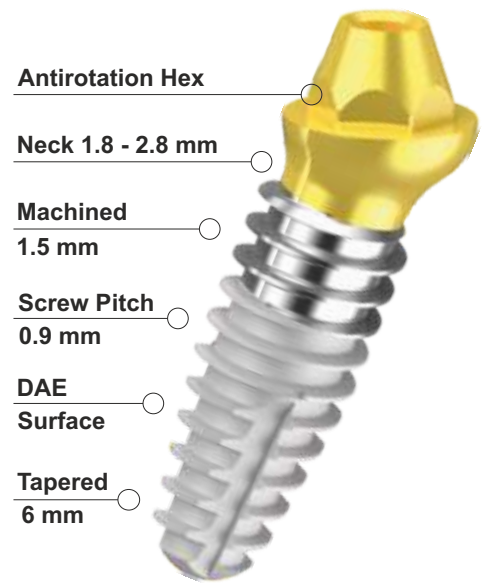

CODE	IMPLANT	LENGTH	PLATFORM	APEX
<b>MMFA 3808-17</b>	Ø 3.8	8.5 mm	17° ●	Ø 1.8
<b>MMFA 3810-17</b>	Ø 3.8	10 mm	17° ●	Ø 1.8
<b>MMFA 3811-17</b>	Ø 3.8	11.5 mm	17° ●	Ø 1.8
<b>MMFA 3813-17</b>	Ø 3.8	13 mm	17° ●	Ø 1.8
<b>MMFA 3815-17</b>	Ø 3.8	15 mm	17° ●	Ø 1.8
<b>MMFA 3808-32</b>	Ø 3.8	8.5 mm	32° ●	Ø 1.8
<b>MMFA 3810-32</b>	Ø 3.8	10 mm	32° ●	Ø 1.8
<b>MMFA 3811-32</b>	Ø 3.8	11.5 mm	32° ●	Ø 1.8
<b>MMFA 3813-32</b>	Ø 3.8	13 mm	32° ●	Ø 1.8
<b>MMFA 3815-32</b>	Ø 3.8	15 mm	32° ●	Ø 1.8

SOFT BONE - D4

STD BONE - D3/D2

HARD BONE - D1

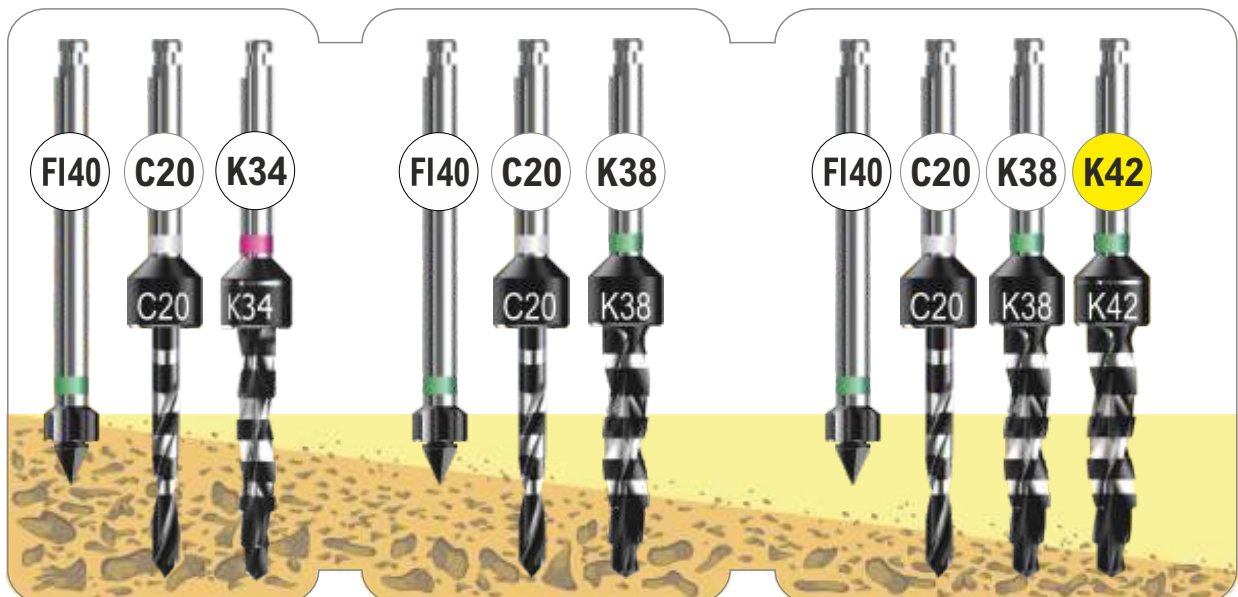

# MMFS 42

## UNI-Q-MUA straight one piece transgingival implant

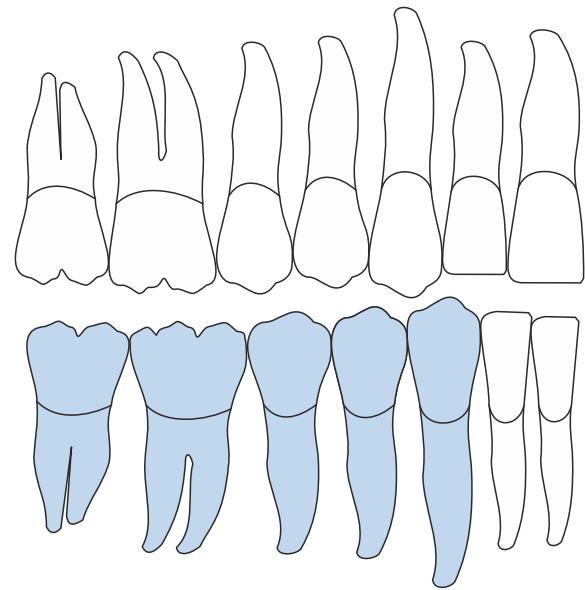
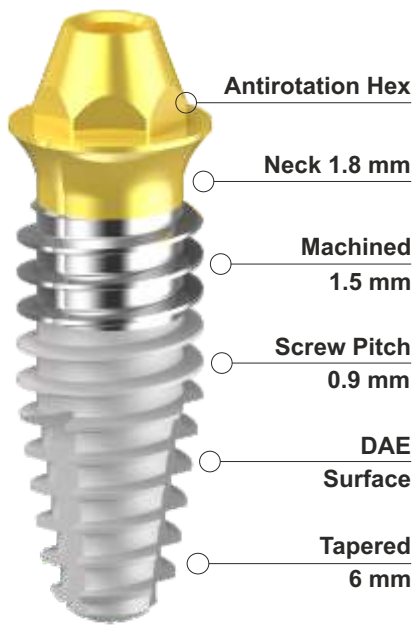

CODE	IMPLANT	LENGTH	PLATFORM	APEX
<b>MMFS 4208</b>	Ø 4.3	8.5 mm	0°	Ø 2.2
<b>MMFS 4210</b>	Ø 4.3	10 mm	0°	Ø 2.2
<b>MMFS 4211</b>	Ø 4.3	11.5 mm	0°	Ø 2.2
<b>MMFS 4213</b>	Ø 4.3	13 mm	0°	Ø 2.2

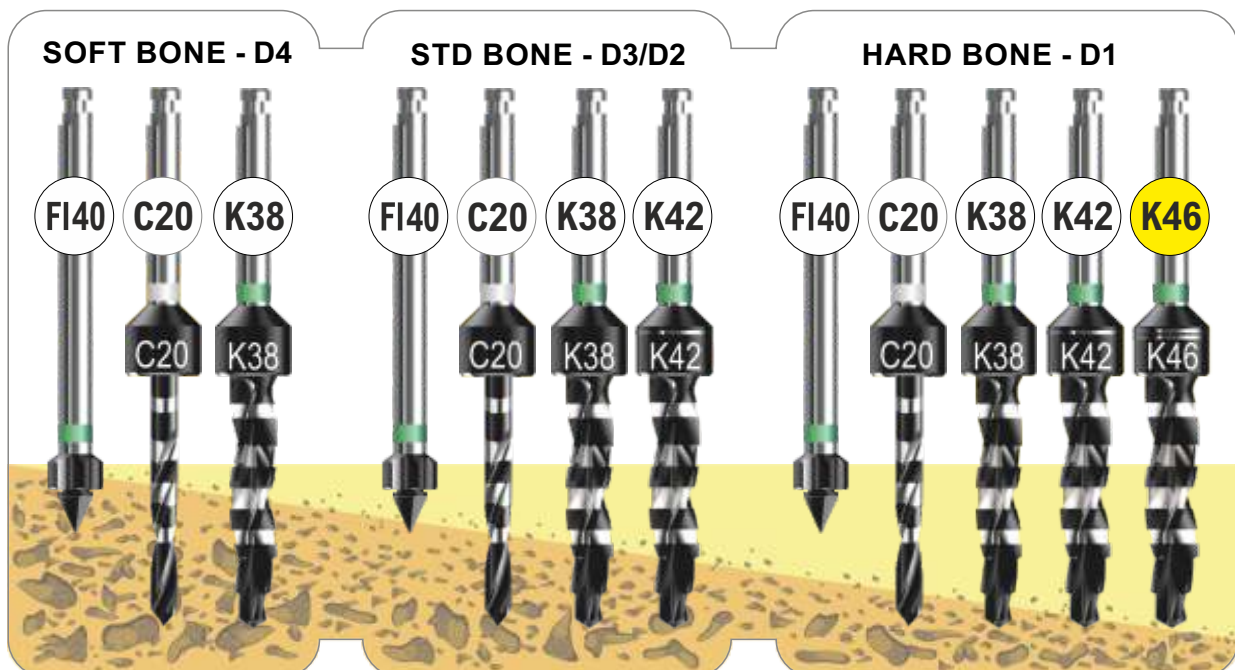

# UNI-Q-MUA angled one piece transgingival implant

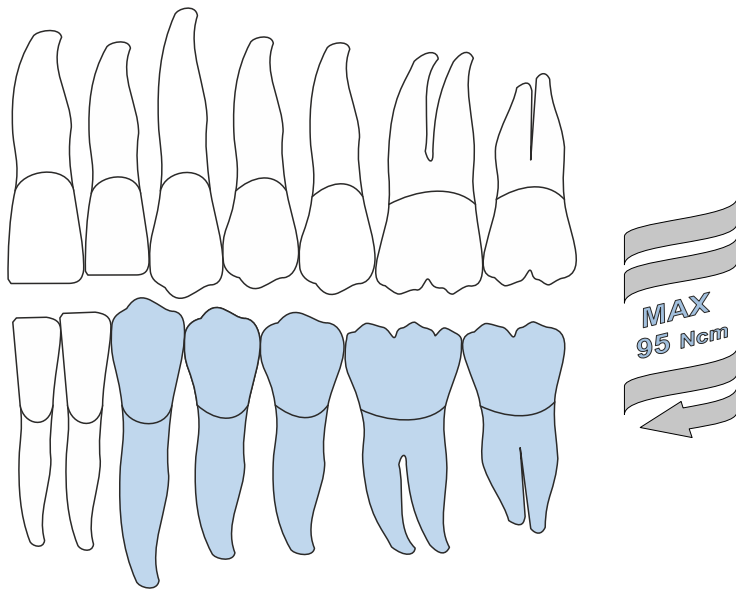

# MMFA 42

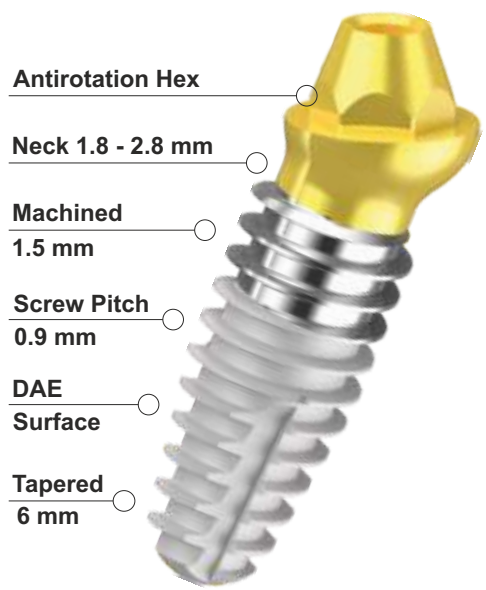

CODE	IMPLANT	LENGTH	PLATFORM	APEX
MMFA 4208-17	Ø 4.3	8.5 mm	17° ●	Ø 2.2
MMFA 4210-17	Ø 4.3	10 mm	17° ●	Ø 2.2
MMFA 4211-17	Ø 4.3	11.5 mm	17° ●	Ø 2.2
MMFA 4213-17	Ø 4.3	13 mm	17° ●	Ø 2.2
MMFA 4215-17	Ø 4.3	15 mm	17° ●	Ø 2.2
MMFA 4208-32	Ø 4.3	8.5 mm	32° ●	Ø 2.2
MMFA 4210-32	Ø 4.3	10 mm	32° ●	Ø 2.2
MMFA 4211-32	Ø 4.3	11.5 mm	32° ●	Ø 2.2
MMFA 4213-32	Ø 4.3	13 mm	32° ●	Ø 2.2
MMFA 4215-32	Ø 4.3	15 mm	32° ●	Ø 2.2

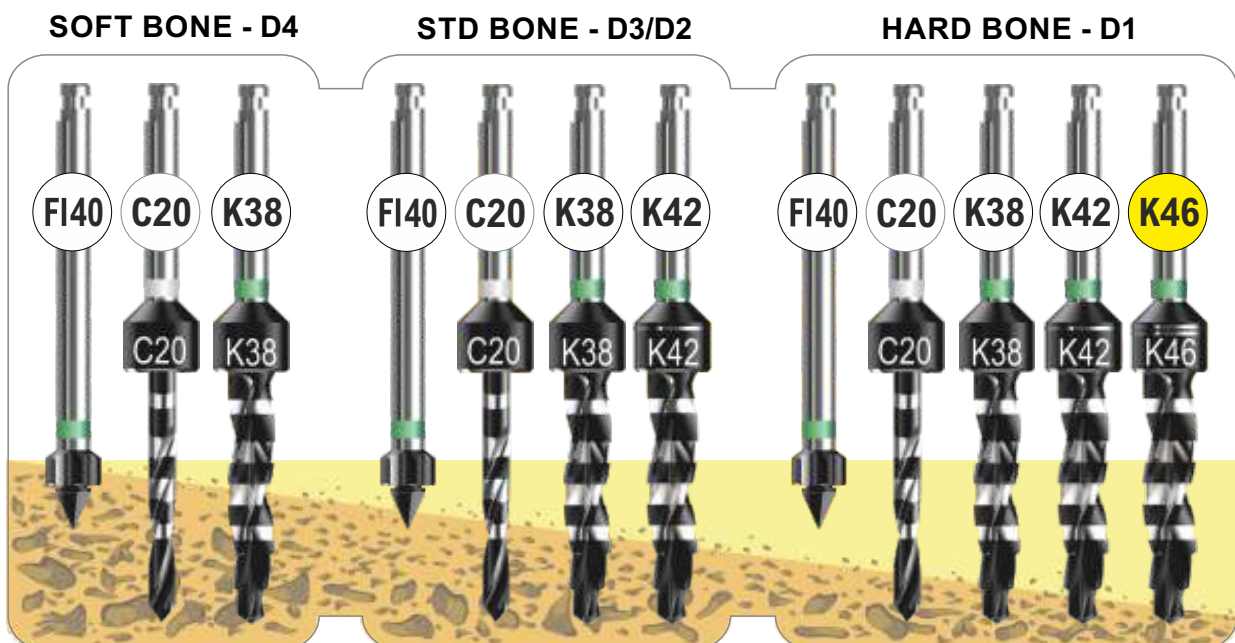

# UNI-Q-MUA surgical tools



**KIT Q**  
Kit Base UNI-Q-MUA  
BOX 02 + 5 Frese + 12 Accessori

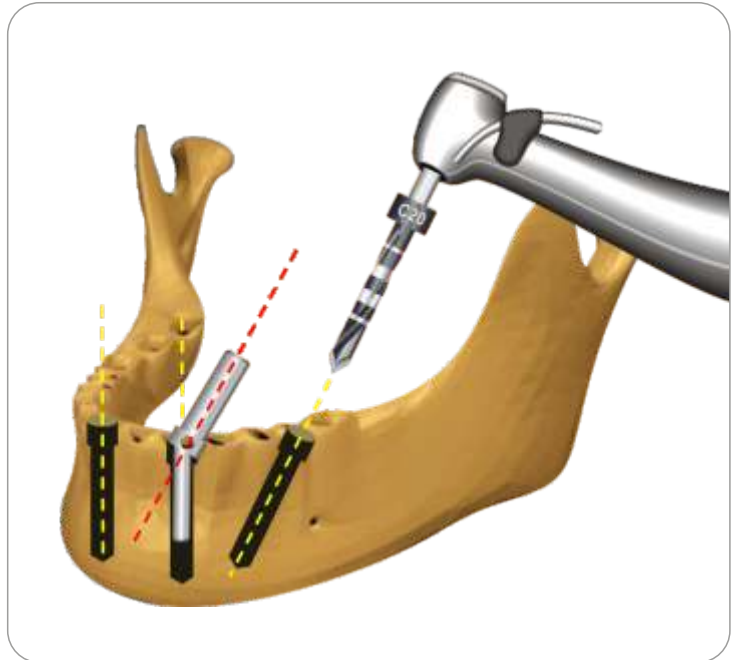

**PIN-Q**



## Perni di Parallelismo Chirurgici - Titanio Gr. 5

Paralleling Pins - Titanium Gr. 5

<b>PIN</b>	Double diameter - 1.8mm / 3mm - 0°
<b>PIN17</b>	Double diameter - 1.8mm / 3mm - 17°
<b>PIN32</b>	Double diameter - 1.8mm / 3mm - 32°
<b>PIN-Q</b>	Peek Pin for Parallelism Control

20Ncm



## Pilastro di Guarigione UNI-Q-MUA - PE

UNI-Q-MUA Healing Abutment - PE

**EP MHA-Q** H 4 mm - Standard Gingival Profile

**DMX 1/2**

Standard Torx Driver

20Ncm



## Pilastro Calcinabile UNI-Q-MUA - Acrilico

UNI-Q-MUA Castable Abutment - Acrylic

**EP MC-Q** Rotating - Standard Gingival Profile

**EP MV-Q** Vite di Ricambio Q - Q Spare Screw

**DMX 1/2**

Standard Torx Driver

# UNI-Q-MUA prosthetics

## Transfer e Analogo UNI-Q-MUA - Titanio Gr. 5

UNI-Q-MUA Impression Coping and Analog - Titanium Gr. 5

**EP MALQ2DS-V** Analog H 10 mm - Universal Shape

**EP MI-Q** Rotating Transfer

**EP MIA-Q** Antirotation Hex Transfer

**EP MVL-Q** Vite di Ricambio Q - Q Spare Screw

**DMX 1/2** Standard Torx Driver



## Pilastro Temporaneo UNI-Q-MUA - Titanio Gr. 5

UNI-Q-MUA Temporary Abutment - Titanium Gr. 5

**EP MT-Q** Rotating Bonding Technique - Incollaggio Passivo

**EP MTS-Q** Rotating Welding Technique - Saldatura Intraorale

**EP MV-Q** Vite di Ricambio Q - Q Spare Screw

**DMX 1/2** Standard Torx Driver



## Pilastro Base CoCr Antirotazione - CoCr

Antirotational CoCr Base Abutment - CoCr

**EP MCCA-Q** Antirotation Hex - Standard Gingival Profile

Intervallo di Fusione 1350°-1430°

Espansione Termica 13,3 - 13,6  $\mu\text{m}/(\text{m}^{\circ}\text{C})$  (20°-200°)

**EP MV-Q** Vite di Ricambio Q - Q Spare Screw

**DMX 1/2** Standard Torx Driver



## Componenti Digitali UNI-Q-MUA - Titanio Gr. 5

UNI-Q-MUA Digital Components - Titanium Gr. 5

**EP MSAQ2 DS** Antirotational Scan Abutment

**EP MTAQ DS** Antirotational Bonding Technique Base Link

**EP MTRQ DS** Rotating Bonding Technique Base Link

**EP MALQ2DS** CAD Laboratory Analog

**EP MV-Q** Vite di Ricambio Q - Q Spare Screw

**DMX 1/2** Standard Torx Driver

## Digital Solutions



# MICRO IMPLANTS

## ONE PIECE TRANSGINGIVAL IMPLANT

MICRO SFERA - MONCONE  
CYLINDRICAL SHAPE

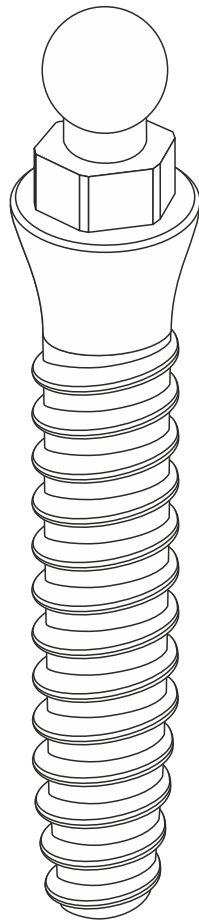

MS

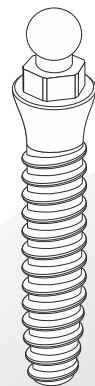

IMPIANTO  
SENZA MOUNTER  
MOUNTERLESS

# MS 27

## MICRO IMPLANTS sphere one piece transgingival implant

### ONE PIECE MOUNTERLESS

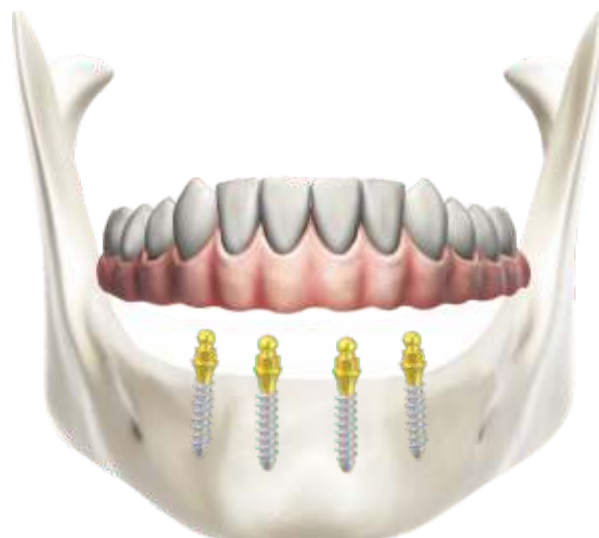
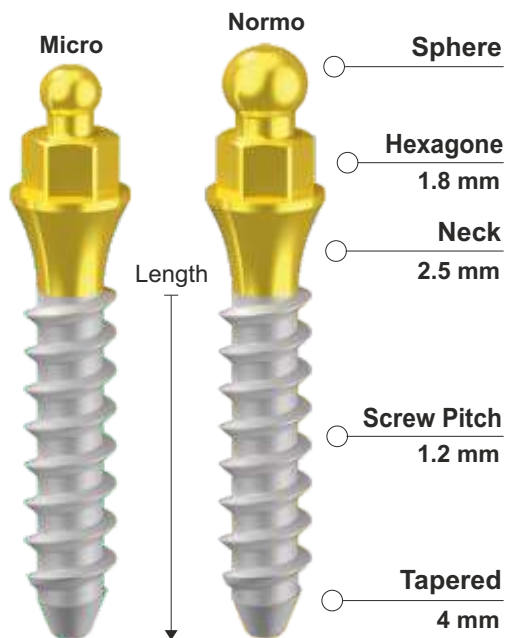

CODE	IMPLANT	LENGTH	PLATFORM	TYPE
<b>MS 2710</b>	Ø 2.7	10 mm	Ø 3.5	Sfera NORMO
<b>MS 2711</b>	Ø 2.7	11.5 mm	Ø 3.5	Sfera NORMO
<b>MS 2713</b>	Ø 2.7	13 mm	Ø 3.5	Sfera NORMO
<b>MSM 2710</b>	Ø 2.7	10 mm	Ø 3.5	Sfera MICRO
<b>MSM 2711</b>	Ø 2.7	11.5 mm	Ø 3.5	Sfera MICRO
<b>MSM 2713</b>	Ø 2.7	13 mm	Ø 3.5	Sfera MICRO

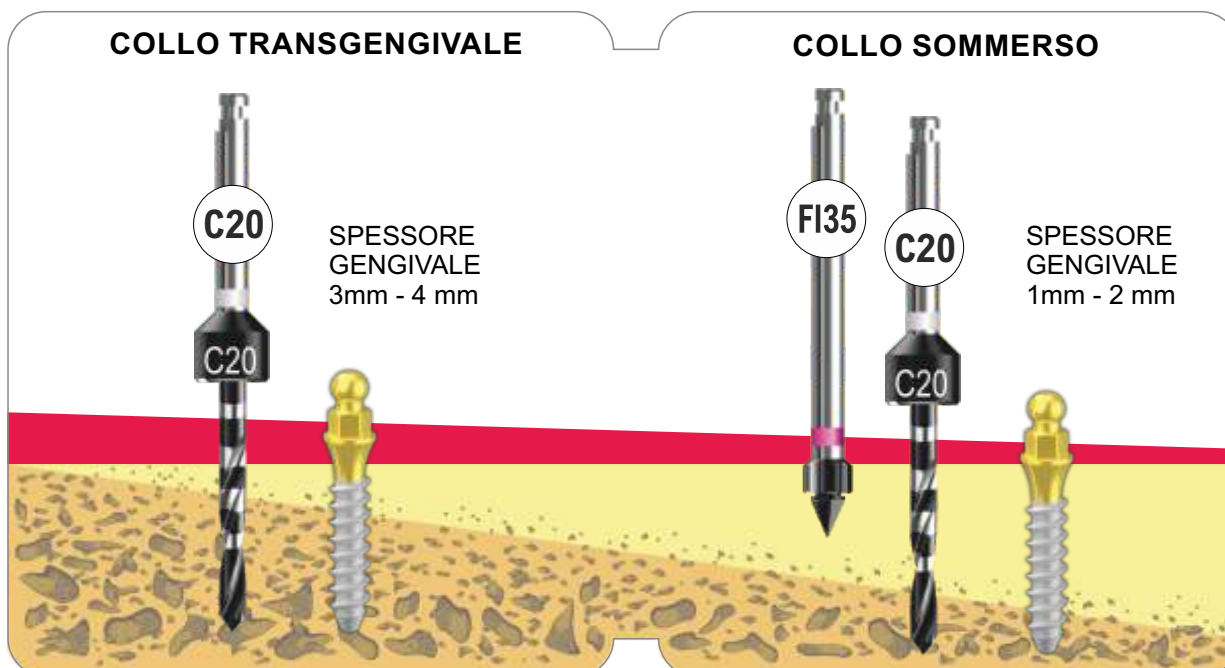

# MICRO IMPLANTS abutment

one piece transgingival implant

# MM 27

## ONE PIECE MOUNTERLESS

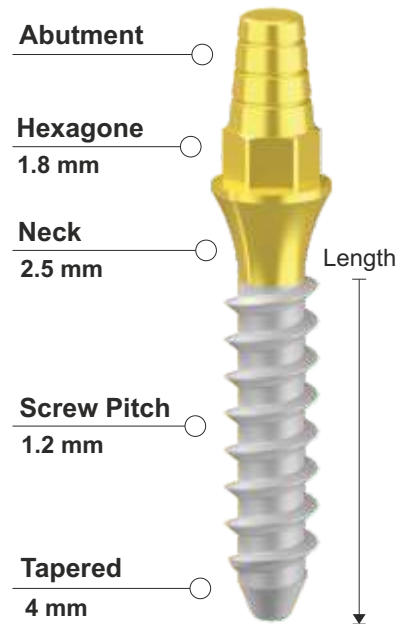
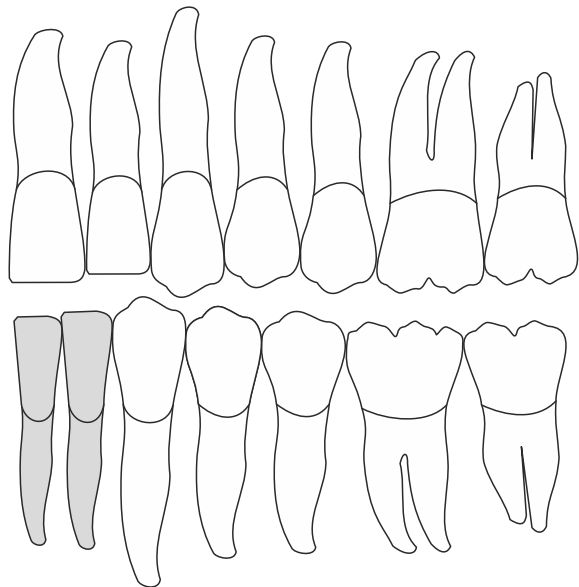

CODE	IMPLANT	LENGTH	PLATFORM	TYPE
MM 2710	Ø 2.7	10 mm	Ø 3.5	Abutment
MM 2711	Ø 2.7	11.5 mm	Ø 3.5	Abutment
MM 2713	Ø 2.7	13 mm	Ø 3.5	Abutment

### Protesica per Mini Implants - Titanio Gr 5

#### Mini Implants Prosthetic Parts - Titanium Gr. 5

PM SN	Normo 2.5mm - Laboratory Analogue
PM SM	Micro 1.8mm - Laboratory Analogue
PM M	Abutment - Laboratory Analogue
PM C	Castable - Universal Antirotational Abutment

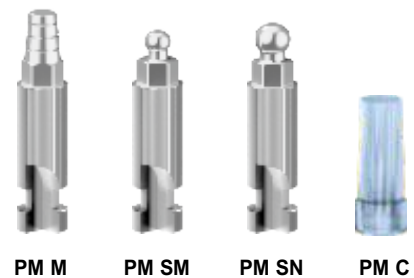

### Strumentario per Mini Implants

#### Mini Implants Instruments

FIS 35	CorTICAL Drill - Ø 3.5 mm
FCS 20	Cylindrical Drill - Ø 2.0 mm - Long 18 mm
PCM	Cricchetto - Ratchet <b>Mini Implant Driver</b>
ACM	Contrangolo - Contrangle <b>Mini Implant Driver</b>



# INSTRUMENTS & DRILLS

## IMPLANT TOOLS

### DRILLS

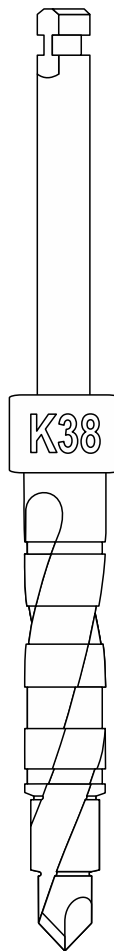

# S standard surgical drills

## FRESE HBM - Hard Bone Management



**07001604** Cortical Drill - Ø 1.6 mm - 11 mm



**04002104** Cortical Drill - Ø 2.1 mm - 11 mm



**FLS2313** Lance Drill - Ø 2.3 mm - 13 mm

## FIS- CORTICALS



**FIS 30** Cortical Drill - Ø 3.0 mm



**FIS 35** Cortical Drill - Ø 3.5 mm



**FIS 40** Cortical Drill - Ø 4.0 mm



**FIS 50** Cortical Drill - Ø 5.0 mm

## FCS - CYLINDRICALS



**FCS 20** Cylindrical Drill - Ø 2.0 mm - Long 18 mm



**FCS 30** Cylindrical Drill - Ø 2.6 mm - Long 18 mm



**FCS 34** Cylindrical Drill - Ø 2.9 mm - Long 18 mm



**FCS 38** Cylindrical Drill - Ø 3.2 mm - Long 18 mm



**FCS 42** Cylindrical Drill - Ø 3.6 mm - Long 18 mm



**FCS 46** Cylindrical Drill - Ø 3.9 mm - Long 18 mm



**FCS 50** Cylindrical Drill - Ø 4.4 mm - Long 18 mm



**FCS 55** Cylindrical Drill - Ø 4.7 mm - Long 18 mm

# S standard surgical drills

## FKS - TAPERED

**FKS 30** Tapered Drill - Ø 2.4 mm - Long 18 mm



**FKS 34** Tapered Drill - Ø 2.9 mm - Long 18 mm



**FKS 38** Tapered Drill - Ø 3.25 mm - Long 18 mm



**FKS 42** Tapered Drill - Ø 3.5 mm - Long 18 mm



**FKS 46** Tapered Drill - Ø 3.85 mm - Long 18 mm



**FKS 50** Tapered Drill - Ø 4.35 mm - Long 18 mm



## FKS - EXTRALARGE

**FKS 60** Tapered Drill - Ø 5.0 mm - 15 mm



**FKS 80** Tapered Drill - Ø 7.0 mm - 15 mm



## MUCOTOMI - TISSUE PUNCHES

**ST M13** Manual Tissue Punche - Ø3.0mm

**ST M14** Manual Tissue Punche - Ø4.1mm

**ST M15** Manual Tissue Punche - Ø5.1mm

**ST M23** Contrangle Tissue Punche - Ø3.0mm

**ST M24** Contrangle Tissue Punche - Ø4.1mm

**ST M25** Contrangle Tissue Punche - Ø5.1mm



# calibrated surgical drills

## FCC 20 - CYLINDRICALS



**FCC 2007** Cylindrical Drill - Ø 2.0 mm - Long 7 mm

**FCC 2008** Cylindrical Drill - Ø 2.0 mm - Long 8,5 mm

**FCC 2010** Cylindrical Drill - Ø 2.0 mm - Long 10 mm

**FCC 2011** Cylindrical Drill - Ø 2.0 mm - Long 11,5 mm

**FCC 2013** Cylindrical Drill - Ø 2.0 mm - Long 13 mm

## FKC 34 - TAPERED



**FKC 3407** Tapered Drill - Ø 2.9 mm - Long 7 mm

**FKC 3408** Tapered Drill - Ø 2.9 mm - Long 8,5 mm

**FKC 3410** Tapered Drill - Ø 2.9 mm - Long 10 mm

**FKC 3411** Tapered Drill - Ø 2.9 mm - Long 11,5 mm

**FKC 3413** Tapered Drill - Ø 2.9 mm - Long 13 mm

## FKC 38 - TAPERED



**FKC 3807** Tapered Drill - Ø 3.2 mm - Long 7 mm

**FKC 3808** Tapered Drill - Ø 3.2 mm - Long 8,5 mm

**FKC 3810** Tapered Drill - Ø 3.2 mm - Long 10 mm

**FKC 3811** Tapered Drill - Ø 3.2 mm - Long 11,5 mm

**FKC 3813** Tapered Drill - Ø 3.2 mm - Long 13 mm

# calibrated surgical drills

## FKC 42 - TAPERED

**FKC 4207** Tapered Drill - Ø 3.5 mm - Long 7 mm



**FKC 4208** Tapered Drill - Ø 3.5 mm - Long 8,5 mm



**FKC 4210** Tapered Drill - Ø 3.5 mm - Long 10 mm



**FKC 4211** Tapered Drill - Ø 3.5 mm - Long 11,5 mm



**FKC 4213** Tapered Drill - Ø 3.5 mm - Long 13 mm



## FKC 46 - TAPERED

**FKC 4607** Tapered Drill - Ø 3.9 mm - Long 7 mm



**FKC 4608** Tapered Drill - Ø 3.9 mm - Long 8,5 mm



**FKC 4610** Tapered Drill - Ø 3.9 mm - Long 10 mm



**FKC 4611** Tapered Drill - Ø 3.9 mm - Long 11,5 mm



**FKC 4613** Tapered Drill - Ø 3.9 mm - Long 13 mm



## FKC 50 - TAPERED

**FKC 5007** Tapered Drill - Ø 4.3 mm - Long 7 mm



**FKC 5008** Tapered Drill - Ø 4.3 mm - Long 8,5 mm



**FKC 5010** Tapered Drill - Ø 4.3 mm - Long 10 mm



**FKC 5011** Tapered Drill - Ø 4.3 mm - Long 11,5 mm



**FKC 5013** Tapered Drill - Ø 4.3 mm - Long 13 mm



# universal surgical drills

## FC - CYLINDRICALS



**FC 2013B** Cylindrical Drill - Ø 2.0 mm - 13 mm

**FC 2018B** Cylindrical Drill - Ø 2.0 mm - 18 mm



**FC 2613B** Cylindrical Drill - Ø 2.6 mm - 13 mm

**FC 2618B** Cylindrical Drill - Ø 2.6 mm - 18 mm



**FC 3013B** Cylindrical Drill - Ø 3.0 mm - 13 mm

**FC 3018B** Cylindrical Drill - Ø 3.0 mm - 18 mm



**FC 3213B** Cylindrical Drill - Ø 3.2 mm - 13 mm

**FC 3218B** Cylindrical Drill - Ø 3.2 mm - 18 mm



**FC 3413B** Cylindrical Drill - Ø 3.4 mm - 13 mm

**FC 3418B** Cylindrical Drill - Ø 3.4 mm - 18 mm



**FC 3813B** Cylindrical Drill - Ø 3.8 mm - 13 mm

**FC 3818B** Cylindrical Drill - Ø 3.8 mm - 18 mm



**FC 4213B** Cylindrical Drill - Ø 4.2 mm - 13 mm

**FC 4218B** Cylindrical Drill - Ø 4.2 mm - 18 mm

## F - SPECIAL DRILLS



**FLS2313** Lance Drill - Ø 2.3 mm - L13 mm

**FLS2318** Lance Drill - Ø 2.3 mm - L18 mm



**FBP** Bone Profiler - Ø 5.0 mm - Int/Ext Hex  
(Velocità Max di rotazione antioraria 80 rpm)



**FT 3038** Trephine - Ø 3.0 mm / Ø 3.8 mm

**FT 4048** Trephine - Ø 4.0 mm / Ø 4.8 mm

**FT 5058** Trephine - Ø 5.0 mm / Ø 5.8 mm

**FT 6068** Trephine - Ø 6.0 mm / Ø 6.8 mm



**PF** Drill Extension - Prolunga per Frese



# guided surgical drills

SLEEVE



PEEK  
BOC415P

SLEEVE



TITANIUM  
BOC415T

SLEEVE



PIN  
BOC15



SMALL DRIVER  
Ø 4.15



SLEEVE



REDUCER  
BOC55P

SLEEVE



PEEK  
BOC55P

SLEEVE



TITANIUM  
BOC55T



LARGE DRIVER  
Ø 5.5

## FG - SPECIAL DRILLS

**FGR P15**

Pins Drill - Ø 1.5 mm

**FGR B55 L**

Bone Mill Drill - Ø 5.5 mm - ● Large

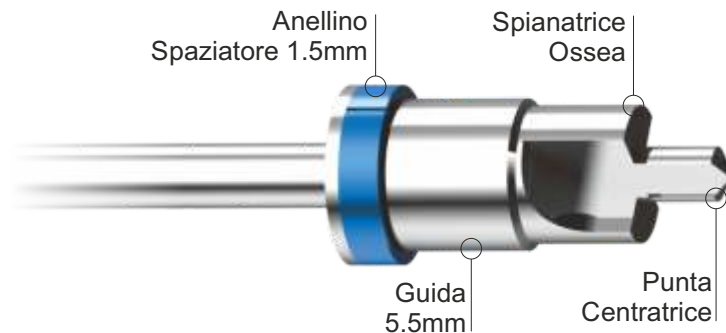

## FG M - MUCOTOMES

**FGR M41 S**

Mucotome Drill - Ø 4.1 mm - ● Small

**FGR M45 L**

Mucotome Drill - Ø 4.5 mm - ● Large

**FGR M55 L**

Mucotome Drill - Ø 5.3 mm - ● Large

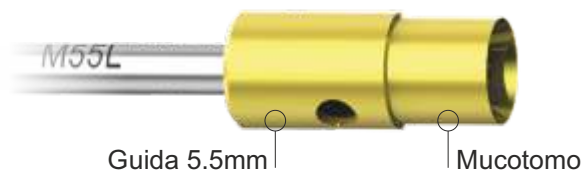

# guided surgical drills



## FG C - CORTICAL DRILLS



- FGR C35 S** Corticall Drill - Ø 3.5 mm - ● Small
- FGR C40 S** Corticall Drill - Ø 4.0 mm - ● Small
- FGR C35 L** Corticall Drill - Ø 3.5 mm - ● Large
- FGR C40 L** Corticall Drill - Ø 4.0 mm - ● Large
- FGR C50 L** Corticall Drill - Ø 5.0 mm - ● Large



## FG 20 S - FIRST DRILLS ● Small Driver



- FGR 2008 S** First Drill - Ø 2.0 mm - Long 8,5 mm
- FGR 2010 S** First Drill - Ø 2.0 mm - Long 10 mm
- FGR 2011 S** First Drill - Ø 2.0 mm - Long 11,5 mm
- FGR 2013 S** First Drill - Ø 2.0 mm - Long 13 mm
- FGR 2015 S** First Drill - Ø 2.0 mm - Long 15 mm

## FG 20 L - FIRST DRILLS ● Large Driver



- FG 2008 L** First Drill - Ø 2.0 mm - Long 8,5 mm
- FGR 2010 L** First Drill - Ø 2.0 mm - Long 10 mm
- FGR 2011 L** First Drill - Ø 2.0 mm - Long 11,5 mm
- FGR 2013 L** First Drill - Ø 2.0 mm - Long 13 mm
- FGR 2015 L** First Drill - Ø 2.0 mm - Long 15 mm



# guided surgical drills

## FG 34 L - 3.4 IMPLANT DRILLS ● Small Driver

- FGR 3408 S** 3.4 Implant Drill - Ø 2.9 mm - Long 8,5 mm
- FGR 3410 S** 3.4 Implant Drill - Ø 2.9 mm - Long 10 mm
- FGR 3411 S** 3.4 Implant Drill - Ø 2.9 mm - Long 11,5 mm
- FGR 3413 S** 3.4 Implant Drill - Ø 2.9 mm - Long 13 mm
- FGR 3415 S** 3.4 Implant Drill - Ø 2.9 mm - Long 15 mm



## FG 34 L - 3.4 IMPLANT DRILLS ● Large Driver

- FGR 3408 L** 3.4 Implant Drill - Ø 2.9 mm - Long 8,5 mm
- FGR 3410 L** 3.4 Implant Drill - Ø 2.9 mm - Long 10 mm
- FGR 3411 L** 3.4 Implant Drill - Ø 2.9 mm - Long 11,5 mm
- FGR 3413 L** 3.4 Implant Drill - Ø 2.9 mm - Long 13 mm
- FGR 3415 L** 3.4 Implant Drill - Ø 2.9 mm - Long 15 mm



## FG 38 S - 3.8 IMPLANT DRILLS ● Small Driver

- FGR 3808 S** 3.8 Implant Drill - Ø 3.3 mm - Long 8,5 mm
- FGR 3810 S** 3.8 Implant Drill - Ø 3.3 mm - Long 10 mm
- FGR 3811 S** 3.8 Implant Drill - Ø 3.3 mm - Long 11,5 mm
- FGR 3813 S** 3.8 Implant Drill - Ø 3.3 mm - Long 13 mm
- FGR 3815 S** 3.8 Implant Drill - Ø 3.3 mm - Long 15 mm



## FG 38 L - 3.8 IMPLANT DRILLS ● Large Driver

- FGR 3808 L** 3.8 Implant Drill - Ø 3.3 mm - Long 8,5 mm
- FGR 3810 L** 3.8 Implant Drill - Ø 3.3 mm - Long 10 mm
- FGR 3811 L** 3.8 Implant Drill - Ø 3.3 mm - Long 11,5 mm
- FGR 3813 L** 3.8 Implant Drill - Ø 3.3 mm - Long 13 mm
- FGR 3815 L** 3.8 Implant Drill - Ø 3.3 mm - Long 15 mm



# guided surgical drills

## FG 42 S - 4.2 IMPLANT DRILLS ● Small Driver



- FGR 4208 S** 4.2 Implant Drill - Ø 3.6 mm - Long 8,5 mm
- FGR 4210 S** 4.2 Implant Drill - Ø 3.6 mm - Long 10 mm
- FGR 4211 S** 4.2 Implant Drill - Ø 3.6 mm - Long 11,5 mm
- FGR 4213 S** 4.2 Implant Drill - Ø 3.6 mm - Long 13 mm
- FGR 4215 S** 4.2 Implant Drill - Ø 3.6 mm - Long 15 mm

## FG 42 L - 4.2 IMPLANT DRILLS ● Large Driver



- FGR 4208 L** 4.2 Implant Drill - Ø 3.6 mm - Long 8,5 mm
- FGR 4210 L** 4.2 Implant Drill - Ø 3.6 mm - Long 10 mm
- FGR 4211 L** 4.2 Implant Drill - Ø 3.6 mm - Long 11,5 mm
- FGR 4213 L** 4.2 Implant Drill - Ø 3.6 mm - Long 13 mm
- FGR 4215 L** 4.2 Implant Drill - Ø 3.6 mm - Long 15 mm

## FG 46 L - 4.6 IMPLANT DRILLS ● Large Driver



- FGR 4608 L** 4.6 Implant Drill - Ø 3.9 mm - Long 8,5 mm
- FGR 4610 L** 4.6 Implant Drill - Ø 3.9 mm - Long 10 mm
- FGR 4611 L** 4.6 Implant Drill - Ø 3.9 mm - Long 11,5 mm
- FGR 4613 L** 4.6 Implant Drill - Ø 3.9 mm - Long 13 mm
- FGR 4615 L** 4.6 Implant Drill - Ø 3.9 mm - Long 15 mm

## FG 50 L - 5.0 IMPLANT DRILLS ● Large Driver



- FGR 5008 L** 5.0 Implant Drill - Ø 4.3 mm - Long 8,5 mm
- FGR 5010 L** 5.0 Implant Drill - Ø 4.3 mm - Long 10 mm
- FGR 5011 L** 5.0 Implant Drill - Ø 4.3 mm - Long 11,5 mm
- FGR 5013 L** 5.0 Implant Drill - Ø 4.3 mm - Long 13 mm



# guided surgical drills

## GUIDED MOUNTERS

- IP4MG 4S** Mounter Guidata - Internal Hex ● Small Drive
- IP4MG 4L** Mounter Guidata - Internal Hex ● Large Drive
  
- SP3MG 3S** Mounter Guidata - External Hex ● Small Drive
- SP4MG 4S** Mounter Guidata - External Hex ● Small Drive
- SP4MG 4L** Mounter Guidata - External Hex ● Large Drive
  
- IP3MG 3S-P** Mounter Guidata - Platinum CC ● Small Drive
- IP3MG 3L-P** Mounter Guidata - Platinum CC ● Large Drive
- IP4MG 4L-P** Mounter Guidata - Platinum CC ● Large Drive

Small Drive



Large Drive



Large Drive



Allineatori di Fase Esagonale  
Hexagonal Phase Aligners



Large Peek Sleeve



Small Peek Sleeve



Large Titanium Sleeve



Small Titanium Sleeve



# surgical kits



**BOX**  
Solo contenitore

**KIT 002**  
C-K-A Multilinea



**KIT FCK**  
Calibrate K



# surgical kits

<b>KIT 001MC</b>	Kit Chirurgico Monolinea Cilindriche - BOX02 + Frese + Accessori
<b>KIT 001MK</b>	Kit Chirurgico Monolinea Coniche - BOX02 + Frese + Accessori
<b>KIT 001PC</b>	Kit Chirurgico Monolinea Platinum Cilindriche - BOX02 + Frese + Accessori
<b>KIT 001PK</b>	Kit Chirurgico Monolinea Platinum Coniche - BOX02 + Frese + Accessori
<b>KIT 002</b>	Kit Chirurgico Standard - BOX + Frese + Accessori
<b>KIT 002P</b>	Kit Chirurgico Platinum Standard - BOX + Frese + Accessori
<b>KIT 004</b>	Kit Chirurgico Mini Implant - BOX 03 + CRND + Frese + Accessori
<b>KIT FCK</b>	Kit Chirurgico Calibrate K - BOX FCK + Frese + Accessori
<b>KIT 009</b>	Kit Chirurgico UNI-Q-MUA 2.0 - BOX 02 + Frese + Accessori
<b>KIT RPS01</b>	Kit Protesico REPLICA - BOX RP01 + 5 Drivers Corti
<b>KIT RPS02</b>	Kit Protesico REPLICA - BOX RP01 + 5 Drivers Corti + Cricchetto Dinamom.
<b>KIT RPL01</b>	Kit Protesico REPLICA - BOX RP01 + 5 Drivers Lunghi
<b>KIT RPL02</b>	Kit Protesico REPLICA - BOX RP01 + 5 Drivers Lunghi + Cricchetto Dinamom.
<b>BOX</b>	Box Chirurgico Implantologia Large - Solo contenitore
<b>BOX 02</b>	Box Chirurgico Implantologia Monolinea Medium - Solo contenitore
<b>BOX RP01</b>	Box Protesico REPLICA - Solo contenitore



**KIT 001**  
Monolinea



Kit Protesico  
REPLICA



# surgical kits

<b>KIT 005</b>	Kit Chirurgico Espansori - BOX 03 + 4 Espansori + Accessori
<b>KIT 006</b>	Kit Chirurgico Espansori Base - BOX 03 + 4 Espansori
<b>KIT PINK</b>	Kit Misuratori di Parallelismo - BOX P + 10 PIN
<b>KIT 007</b>	Kit Rimozione Impianti EXT - BOX 03 + 2 Estrattori + Accessori
<b>KIT RI</b>	Kit Rimozione Impianti REPLICA - BOX + 3 Estrattori + 4 Viti + Accessori
<b>KIT RV</b>	Kit Rimozione Viti Fratturate REPLICA - BOX + 2 Frese + Guida + Accessori
<b>KIT 012</b>	Kit REVO Chirurgia Guidata - BOX + 59 Frese + Accessori
<b>KIT 012L</b>	Kit REVO Chirurgia Guidata solo Frese Larghe - BOX + 36 Frese + Accessori
<b>BOX GR</b>	Box REVOLUTION Chirurgia Guidata - Solo contenitore
<b>KIT KN</b>	Kit K Narrow - Box + Frese + Accessori
<b>BPIF</b>	Base Svita Impianti - Base in Titanio per la Rimozione del Mount
<b>KBS</b>	Kit Boccole Spaziatrici - 8 Boccole 2 colori per tipo + Box Inox
<b>RBS</b>	Ricambi Boccole Spaziatrici - 8 Boccole 2 colori per tipo



**KBS** Kit Boccole Spaziatrici REVO



**BPIF** Base Svita Impianti

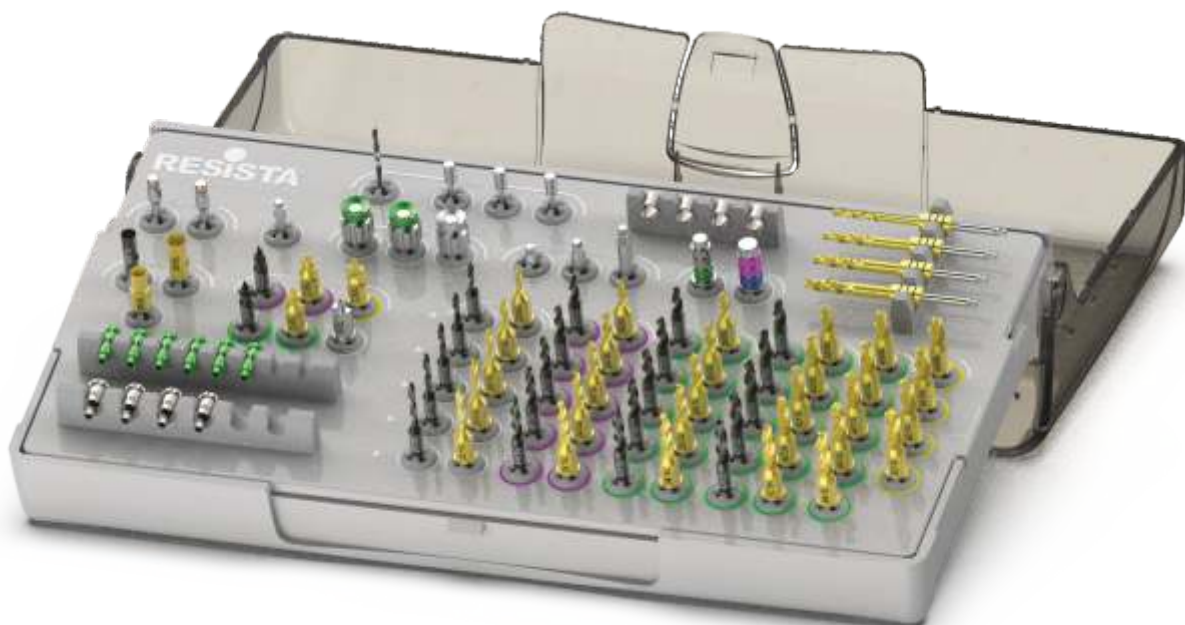

Guided Surgery REVO (Full Optional su Richiesta)

# computer guided surgery



# computer guided surgery

**MASCHERINA CHIRURGICA** - Mascherina on demand multi-impianti

**SURGICAL GUIDE** - Multi-implants on demand surgical guide

**DS PAK** Progetto + Mascherina + Modello + Boccole

**NB** - Supporto tecnico sul posto per i primi 3 interventi  
Kit Chirurgico in comodato d'uso per i primi 3 interventi



**MASCHERINA CHIRURGICA** - Mascherina on demand multi-impianti

**SURGICAL GUIDE** - Multi-implants on demand surgical guide

**DS PAK-M** Progetto + Mascherina + Boccole

**NB** - Supporto tecnico sul posto per i primi 3 interventi  
Kit Chirurgico in comodato d'uso per i primi 3 interventi

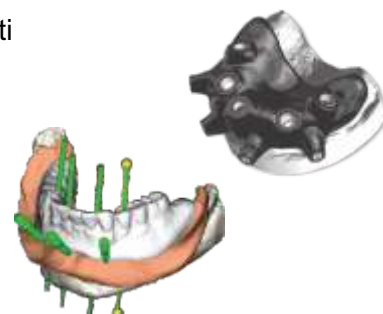

**MODELLO MASTER** - Modello stereolitografato, preforato per analoghi

**MASTER MODEL** - Pre-drilled stereolithographed model for analog

**DS MOD** Modello da stampa Digitale di precisione



**MASCHERINA CHIRURGICA** - Mascherina on demand multi-impianti

**SURGICAL GUIDE** - Multi-implants on demand surgical guide

**DS PAK 1** Mascherina 1 Impianto + Modello + Boccole

**DS PAK 4** Mascherina 4 Impianti + Modello + Boccole

**DS PAK 8** Mascherina 8 Impianti + Modello + Boccole

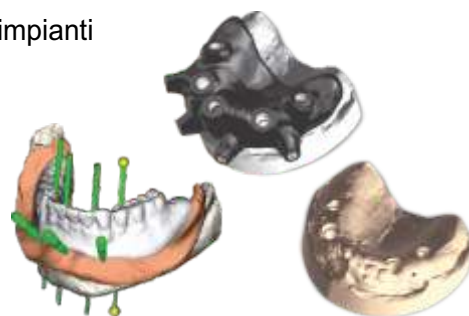

**PROTESI PROVVISORIA IMMEDIATA** - PMMA Stratificato Fresato + Armatura in Titanio Fresata

**IMMEDIATE TEMPORARY PROSTHESIS** - Drilled PMMA + Milled Titanium Framework

**DS PTD** Protesi Provvisoria Total Digital - PMMA + Armatura



# computer guided surgery

1

## **MODELLO PANORAMICO** - Ottenuto dalla ribasatura della protesi

Modello di precisione, integro, squadrato e rifinito

Materiale: Gesso di qualità Classe 4

Ribasare la protesi con materiale da impronta o prendere un'impronta di precisione se parzialmente edentulo



2

## **DUPLICATO DELLA PROTESI** - Realizzato sul modello panoramico

Copia conforme della protesi mobile senza sottosquadri vestibolari

Materiale: Resina ortodontica trasparente

Il dupliato è una copia di precisione di una protesi o di una ceratura diagnostica se il paziente è parzialmente edentulo



3

## **MARKER RADIOLOGICI** - Incollaggio delle palline di quarzo

6/8 palline, in posizioni sfalsate non lineari tra loro

Materiale: Sfere di quarzo delle sterilizzatrici a palline

Le palline vanno incollate con cianocrilato per metà del loro diametro nella resina ed il resto emergente, con posizioni sfalsate tra loro



4

## **TAC CONE BEAM** - Rimuovere ponti e corone metalliche se possibile

Paziente con duplicato in bocca e spaziatore intraorale tra le arcate

Dati DICOM standard inviati via mail in una cartella compressa

Il metallo di ponti e corone genera grandi quantità di scattering che altera l'interpretazione dei dati DICOM e la precisione



5

## **STL ANATOMIA e WAXUP PROTESICO** - 2/3 File STL

1 File STL Modello Gengivale/Dentale

1 File STL Modello + WaxUp Protesico (Duplicato della Protesi)

Inviare per e-mail in cartella compressa



6

## **CREAZIONE DEL CASO** - Ambiente virtuale per progettazione chirurgica

Trasformiamo il vostro materiale in un caso unico, già caricato nel

Programma di Pianificazione e ve lo condividiamo sul vostro Software

I file STL di modello, duplicato e/o scan-marker, li sovrapponiamo alla TAC (matching) all'interno del programma, per visualizzare ossa, tessuti molli e protesi

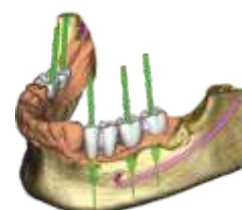

# computer guided surgery



## CORSI DI FORMAZIONE TEORICO/PRATICI SU PC

Il futuro è digitale e la chirurgia computer guidata cammina al fianco della rivoluzione cad-cam che sta trasformando il nostro lavoro

impararne le basi, conoscerne le potenzialità, comprenderne i limiti per evitare errori e per migliorare il nostro quotidiano

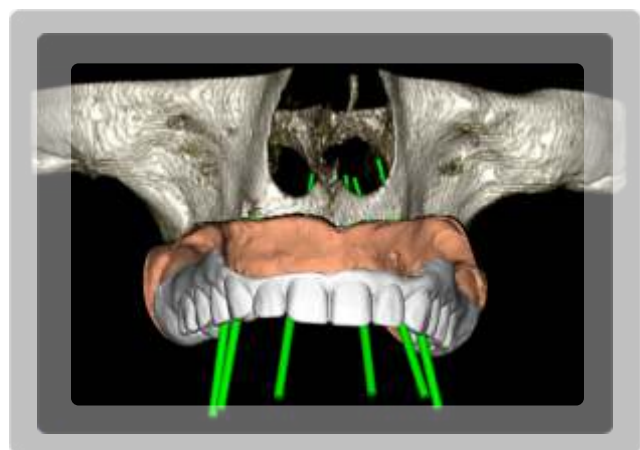
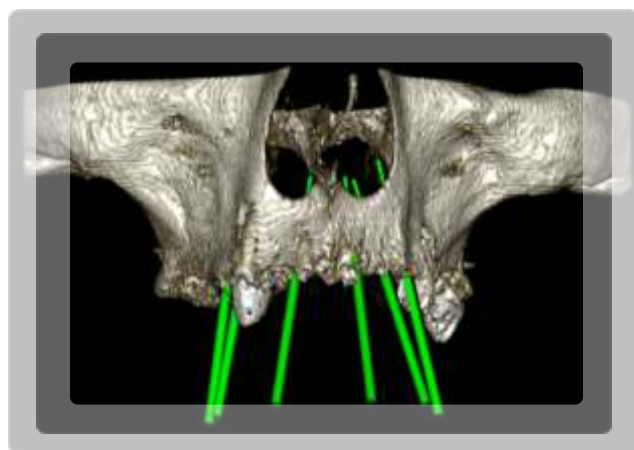

# INSTRUMENTS & TOOLS

## IMPLANT TOOLS

### DRIVERS

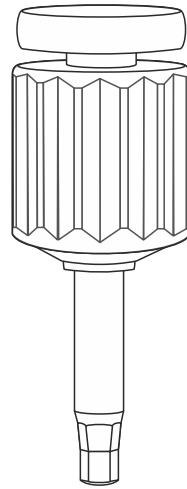

# instruments and tools

## CACCIAVITI MANUALI - MANUAL SCREW DRIVERS



**DM 01** Hexagonal 1.27 - Short - 12mm



**DM 02** Hexagonal 1.27 - Medium - 17mm

**DM 03** Hexagonal 1.27 - Long - 27mm



**DMX 01** Torx - Short - 15mm

**DMX 02** Torx - Long - 20mm

**DMRP120S** Hexagonal 1.20 - Short

**DMRP120L** Hexagonal 1.20 - Long



**DM T6DS** T6 Angled Torx Driver - 15mm



**DMEQ** Equator Squared - Short - 15mm

## CACCIAVITI DA CONTRANGOLO - CONTRA-ANGLE SCREW DRIVERS



**DC 01** Hexagonal 1.27 - Short - 15mm



**DC 02** Hexagonal 1.27 - Medium - 20mm

**DC 03** Hexagonal 1.27 - Long - 30mm



**ACDRCA** Hexagonal 1.20

**DC T6DS** T6 Angled Torx Driver - 20mm



**DCEQ** Equator Squared - Medium - 20mm



**DCX 01** Torx - Short - 15mm

**DCX 02** Torx - Long - 20mm

# instruments and tools

## CACCIAVITI DA CRICCHETTO - TORQUE CONTROLLER DRIVERS

**DCD 01**      **Hexagonal 1.27** - Short - 15mm

**DCD 02**      **Hexagonal 1.27** - Medium - 20mm

**DCD 03**      **Hexagonal 1.27** - Long - 30mm

**DCDX 01**    **Torx** - Short - 15mm

**DCDX 02**    **Torx** - Long - 20mm

**DCDM**        **Hexagonal** - Monconi Toronto Diritti



## AVVITATORI MANUALI - FINGER MANUAL DEVICE

**DGM**            Digitale Manuale - Manual Implant Driver



**DKX**            Avvitatore Manuale per RA - RA Manual Driver



**UNADCRCAES35**    Adattatore CRD2 da Es. 3,5 a RA  
CRD2 Adapter from Hex 3,5 to RA



[NB Controllare compatibilità vecchio e nuovo ed in alternativa catalogo REPLICA](#)

# instruments and tools

## PROLUNGHE DA CRICCHETTO - RATCHET IMPLANT DRIVERS

I E



**PC 01R** Short - Hexagonal Implant Driver

**PC 02R** Medium - Hexagonal Implant Driver

**PC 03R** Long - Hexagonal Implant Driver



**PR PC** Prolunga per PC - PC Extension

## AVVITATORI DA CONTRANGOLO - CONTRA-ANGLE IMPLANT DRIVERS

I E



**AC 01** Short - Hexagonal Implant Driver

**AC 02** Medium - Hexagonal Implant Driver

## AVVITATORE PER MINI IMPIANTI - MINI IMPLANT DRIVER



**PCM** Cricchetto - Ratchet **Mini Implant** Driver



**ACM** Contrangolo - Contrangle **Mini Implant** Driver

# instruments and tools



## Accessori per Applicazione Manuale

### Accessories for Manual Application

**CD LAB** Chiave Digitale da Laboratorio Es. 3,5

**UNADCR CAES35**  Adattatore da Es. 3,5 a RA

0° 17° 32°



## Perni di Parallelismo - Titanio Gr. 5

### Paralleling Pins - Titanium Gr. 5

**PIN** Double diameter - S 1.8mm / L 3mm - 0°

**PIN17** Double diameter - S 1.8mm / L 3mm - 17°

**PIN32** Double diameter - S 1.8mm / L 3mm - 32°

**PIN K** Kit Misuratori di Parallelismo Calibrati (10 PIN + BOX)

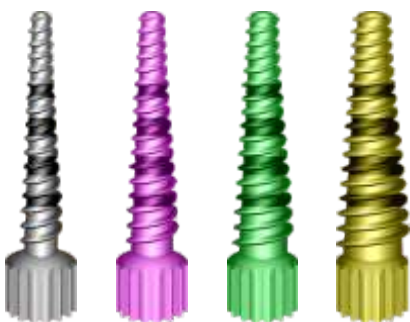
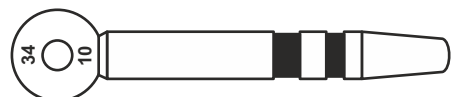

<b>A 1.3</b>	<b>A 1.6</b>	<b>A 1.9</b>	<b>A 2.4</b>
<b>B 2.1</b>	<b>B 2.8</b>	<b>B 3.5</b>	<b>B 4.3</b>
<b>C 2.4</b>	<b>C 3.1</b>	<b>C 3.8</b>	<b>C 4.6</b>

## Osseo Espansori e Compattatori - Titanio Gr. 5

### Bone Expanders and Compactors - Titanium Gr. 5

**EXP** 4 Progressive diameters

**KIT 005** Expander Surgical Kit

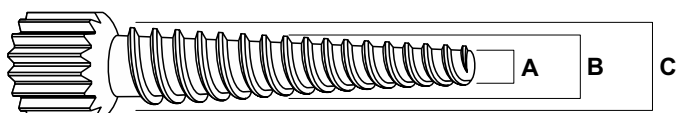

# instruments and tools

## Avvitatori Manuali - Acciaio Inox

Manual Driver - Stainless Steel



**CRND** Cricchetto non Dinamometrico - No Torque Control Ratchet



CRD2-G



**CRD2** Cricchetto Dinamometrico 10/70 Ncm - Torque Control

**CRD2-G** Ghiera Cricchetto CRD2 con Attacco PC - CRD2 Ratchet Wheel with PC Connection



**CRDP2** Cricchetto Dinamometrico Protesico 10/70 Ncm - Torque Control



**CDL** Avvitatore Diritto Manuale - Long Manual Driver

## Sonde e Misuratori - Acciaio Inox

Probes and Meters - Stainless Steel

**ST PRO SL1** Sonda Compattatore Doppia - Sinus Lift System



**SOM** Sonda Chirurgica in Titanio  
Titanium Surgical Probe

# mini sinus lift

Frese Taglienti 120°



## PRO Sinus Lift - Mini Rialzo del Seno per via Crestale

### PRO Sinus Lift - Mini Sinus Lift with Crestal Approach

**PRO SL Kit** Kit Completo Box + Frese + Stop + Accessori

- FC 20** Fresa ● Tagliente 120° - Ø 2.0
- FC 2026** Fresa ● Tagliente 120° - Ø 2.0/2.6
- FC 2531** Fresa ● Tagliente 120° - Ø 2.5/3.1
- FC 31P** Fresa ● Atraumatica 180° - Ø 3.1
- FC 31PTX** Fresa ● Atraumatica TaglioX 180° - Ø 3.1
- FC 31R** Fresa ● Raggiata Atraumatica - Ø 3.1
- FC 3136R** Fresa ● Raggiata Atraumatica - Ø 3.1/3.6

**KIT ST** 6 Titanium Drill Stoppers  
(6.0/7.0/8.5/10/11.5/13)

**STP KIT** 11 Titanium Drill Stoppers  
(1.0/2.0/3.0/4.0/5.0/6.0/7.0/8.5/10/11.5/13)

**ST** Titanium Drill Stopper 1 pz. (Es. ST1, ST2, ST3)



Frese Atraumatiche (Max 100 rpm)



Frese Raggiate (Max 80 rpm)



# instruments and surgery

## IMPIANTI FRATTURATI

### UNIVERSAL IMPLANT EXTRACTOR

**IMPIANTO FRATTURATO**

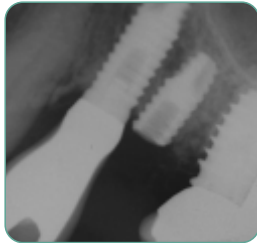

**IMPIANTO SOSTITUITO**

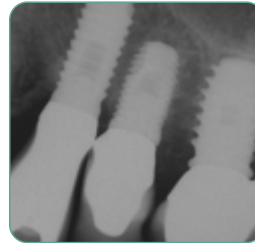

**RIMOZIONE IMPIANTO IN AVVITAMENTO ANTIORARIO**



**SOSTITUZIONE IMMEDIATA CON NUOVO IMPIANTO**



**RIVESTIMENTO IN DLC**  
Durezza e Minore Attirito

**CONICITÀ PROGRESSIVA**  
Incrementale

**FILETTO 3 PRINCIPI**  
120Ncm

**ACCIAIO EXTRADURO**  
68 Rockwell



**EXT** Implant Extractor - 1 pcs.

**KIT 007** Implant Extractor Kit - 2 Extractors + 1 Box + CRND

## Siringhe per Anestesia - Inox

Anesthesia Syringes - Stainless Steel



**PERIPEN**

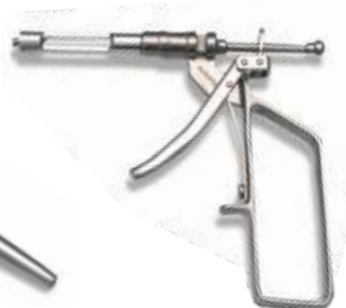

**PERIPRESS**



**22** PERIPRESS - Siringa Inox 1.8cc - Set 2 Portafiala

**32** PERIPRESS - Siringa Standard 1.8cc - Set 2 Portafiala

**118** PERIPEN - Siringa Inox 1.8cc - Set 2 Portafiala AM/EU



**Ing. C. A. Issoglio & C. S.r.l.**  
Via F.lli Di Dio, 68 - 28887 Omegna (VB) - ITALIA  
Tel. +39.0323.828.004 - Fax +39.0323.828.914  
[www.resista.it](http://www.resista.it) - [info@resista.it](mailto:info@resista.it)

REV 03 - 31/03/2023